



POWER FROM WITHIN

GUIDA TECNICA  
**REGOLATORE  
DIGITALE DSR**

# DSR DIGITAL REGULATOR

TECHNICAL GUIDE



<b>INDEX</b>	pag. 2
<b>INTRODUCTION</b>	pag. 3
<b>MAIN CHARACTERISTICS</b>	pag. 3
1. Architecture of the system	pag. 3
1.1 Regulator	pag. 3
1.2 Communications module	pag. 3
2. Technical characteristics	pag. 3
3. Inputs and Outputs: technical specifications	pag. 5
4. Block diagram	pag. 5
<b>INSTALLATION</b>	pag. 5
1. Overall dimensions drawings	pag. 5
2. Connections	pag. 6
3. Terminals	pag. 6
4. DSR connections for typical applications	pag. 6
5. Setting up the regulator	pag. 6
5.1 Alternator voltage signals	pag. 6
5.2 Calibrating sensing	pag. 6
5.3 50/60 Signal	pag. 6
6. Serial communications	pag. 10
7. APO Contact	pag. 10
8. VOLT, STAB,Hz and AMP Trimmers	pag. 10
9. Vext Input	pag. 10
<b>SERIAL CONNECTION</b>	pag. 11
<b>PARAMETERS AND OPERATING DATA</b>	pag. 12
1. ModBus registry list	pag. 12
2. Word of configuration (Parameter P[10])	pag. 13
3. RAM location reference, activation of saturation in analog remote control	pag. 13
4. Volatile memory addresses	pag. 14
5. Fourth Status Word (Location L[39])	pag. 14
<b>SETTING OF VOLT, STAB, AMP and Hz PARAMETERS</b>	pag. 15
1. Voltage	pag. 15
1.1 Setting voltage	pag. 15
1.2 Slow voltage variations	pag. 15
2. Stability	pag. 16
2.1 Adjustment of stability	pag. 16
3. Excitation overcurrent	pag. 20
3.1 Description	pag. 20
3.2 Calibration with a supervision unit	pag. 21
3.3 Calibration without a supervision unit	pag. 21
4. Underspeed	pag. 21
4.1 Description	pag. 21
4.2 Calibration with a supervision unit	pag. 21
4.3 Calibration without a supervision unit	pag. 22
5. Overspeed	pag. 22
6. Other parameters	pag. 22
6.1 Vout / Vaux Ratio	pag. 22
6.2 V/F slope at start up	pag. 23
6.3 Short circuit time	pag. 23
<b>CONTROLLING OF REGULATOR ALARMS</b>	pag. 24
1. Table of recapitulation	pag. 24
2. Alarm signals with the indicator lights	pag. 24
3. Description of alarms	pag. 25
4. APO Output	pag. 26
5. Board operation time	pag. 26
	pag. 31
<b>APPENDIX</b>	pag. 27
<b>TECHNICAL REFERENCE GUIDES</b>	pag. 28

The information contained in this manual may be modified without advance notice.

This revision supersedes and replaces all previous editions.

Even partial reproduction of this manual is prohibited, with any means whatsoever, without prior written authorisation by Mecc Alte S.p.A.

## INTRODUCTION

This manual contains information on the operation and use of the DSR digital regulator.



In order to avoid damage to persons and/or property, only qualified personnel, having full knowledge and understanding of the information contained in this manual, should perform the procedures described herein; when power to the unit is on, the voltage present may be lethal for the operator.



All connections must be made with the power off.

The plastic protections on connectors J1 and J2 must not be removed for any reason whatsoever.

## MAIN CHARACTERISTICS

### 1. Architecture of the system

The DSR is a voltage regulator for synchronous alternators, designed for stand alone working and calibration; to maximize performance, the regulator should be understood as part of a system made up of at least three components: the DSR (control unit), a communications module (USB2DxR, for example) and a supervision unit, as illustrated in figure 5.

The connectors for connection to and from the power generator and communications module are located on the DSR regulator.

The supervision unit can be made up of a personal computer, another “synoptic” device or both; it does not have the function of controlling the system in real time, but allows programming and visualisation of all operational parameters of the DSR.

If it is equipped with a USB interface, for its connection it is possible to use the communication module USB2DxR.

#### 1.1 Regulator

Since the regulator is designed to control many different types of generators, it must be appropriately configured to obtain the best performance; most of the settings are stored in a non-volatile integrated memory (EEPROM). The first time the regulator is turned on, a default configuration will be present, which satisfies the most widely requested characteristics and is suitable to facilitate installation: the trimmers are active and the inputs for the external potentiometer and the 60 Hz jumper are enabled, therefore the basic calibrations can be performed without the use of additional equipment.

The regulator is available in two versions called DSR and DSR/A, the first is the standard one, optimized for Mecc Alte alternators from series 3 to 38, the second is optimized for Mecc Alte alternators series 40-46; the two versions differ mainly in some default parameters.

NOTE: the parameter that defines the output voltage (with the VOLT trimmer disabled) is set on 0 (so that the adjustment takes place on the minimum voltage)

#### 1.2 Communications module

The communication module USB2DxR (provided to be connected on the COM connector of the DSR) has a USB port through which it is possible to set the parameters (both for configuration and operation) and “monitor” the operation of the generator.

### 2. Technical Characteristics of the device on board generator

- Full digital controlled regulator, based on DSP
- On-board machine installation
- Suitable for all self-regulated alternators
- Voltage supply: 40Vac÷270Vac (from auxiliary winding, output voltage or PMG)
- Frequency range: 12Hz ÷ 72Hz
- “Sensing” of voltage with true rms or average measurement (70÷280 Vac)
- Maximum continuous output current: 5A<sub>dc</sub>;
- Precision of voltage regulation: ± 1% from no-load to nominal load in static condition, with any power factor and for frequency variations ranging from -5% to +20% of the nominal value.

- Precision of voltage regulation:  $\pm 1\%$  from no-load to nominal load in static condition, with any power factor and for frequency variations ranging from  $-5\%$  to  $+20\%$  of the nominal value.
- Transient power drops and overvoltage within  $\pm 15\%$
- Voltage recovery time within  $\pm 3\%$  of the value set, in less than 300 msec.
- Transient overvoltage during start up: less than 5% of nominal voltage.
- Single phase sensing
- Parameters: VOLT, STAB, AMP and Hz can be set with trimmers (default) 50/60Hz through a “jumper” (default); all parameters can be programmed via software.
- Analogical remote control of output voltage is possible through external voltage (0÷2,5Vdc) or with a 10 Kohm linear potentiometer.
- Environmental temperature:  $-25^{\circ}\text{C} \div +70^{\circ}\text{C}$
- Underspeed protection with adjustable threshold and slope
- Underexcitation alarm / loss of excitation (4)
- Excitation overcurrent protection with delayed intervention
- Management of temporary short circuits (start up of asynchronous motors)
- (Non-isolated) Open collector output signalling the intervention of protections with a configurable activation for individual alarms, possibility to delay the intervention and selectable active level (4)
- Abnormal operation conditions storage (type of alarm, number of events, duration of the last event, total time)
- Memorization of the regulator operation time (starting from revision 11 of the Firmware)
- USB communication interface (with an optional USB2DxR module)

**WARNING : Operation of the DSR is not specified below 12 Hz.**

### 3. Inputs and Outputs: technical specifications

TABLE 1 : CONNECTOR CN1				
Terminal <sup>(1)</sup>	Name	Function	Specifications	Notes
1	Exc-	Excitation	Continuous Rating: 5Adc Transitory Rating: 12Adc at peak	
2	Aux/Exc+			
3	Aux/Exc+	Power	Frequency: from 12Hz to 72Hz Range: 40Vac - 270Vac	
9	Aux/Neutral			
4	F_phase	Sensing	Range: 140Vac - 280Vac Burden: <1VA	Measurement of average value (rectified) or actual effective value for voltage adjustment
5	F_Phase			
6	H_phase		Range: 70Vac - 140Vac Burden: <1VA	
7	H_phase			
8	Aux/Neutral			
10	Vext/Pext	Input for remote voltage control	Type: Not insulated Range: 0 - 2,5 Vdc or 10K Potentiometer Adjustment: from $-14\%$ to $+14\%$ <sup>(3)</sup> Burden: 0 - 2 mA (sink) Max length: 30m <sup>(2)</sup>	Tolerates voltages from - 5V to + 5V but for values exceeding the range it is automatically disabled
11	Common			
12	50/60Hz	50/60 Hz Jumper Input	Type: Not insulated Max length: 3m	Selection of underspeed protection threshold 50·(100%-αHz%) or 60·(100%-αHz%) αHz% is the position relative to the Hz trimmer or the percentage value of parameter 21
13	Common			
14	A.P.O.	Active protections output	Type: Non-insulated open collector Current : 100mA Voltage: 30V Max length: 30m <sup>(2)</sup>	Programmable : active level <sup>(4)</sup> activating alarm and delay time
15	Common			

NOTE (1) The terminals are connected to each other on the board: 2 with 3, 4 with 5, 6 with 7, 8 with 9, 11 with 13 and 15.

NOTE (2) With external EMI filter SDR 128/K, see Fig.4 (3m without EMI filter)

NOTE (3) Starting from revision 10 of the Firmware. It is convenient do not exceed  $\pm 10\%$

NOTE (4) Starting from rev. 18 of the firmware

TABLE 2 : TRIMMERS		
Name	Function	Notes
VOLT	Voltage Calibration	From 70Vac to 140Vac or from 140Vac to 280Vac, see paragraph "Setting the voltage"
STAB	Calibration of dynamic response	Adjustment of proportional gain, see paragraph on "Stability"
Hz	Calibration of underspeed protection intervention threshold	Variation up to -20% with respect to the nominal speed value set in jumper/parameter 50/60.
AMP	Calibration of excitation overcurrent protection	See paragraph "Calibration of excitation overcurrent protection"

#### 4. Block diagram

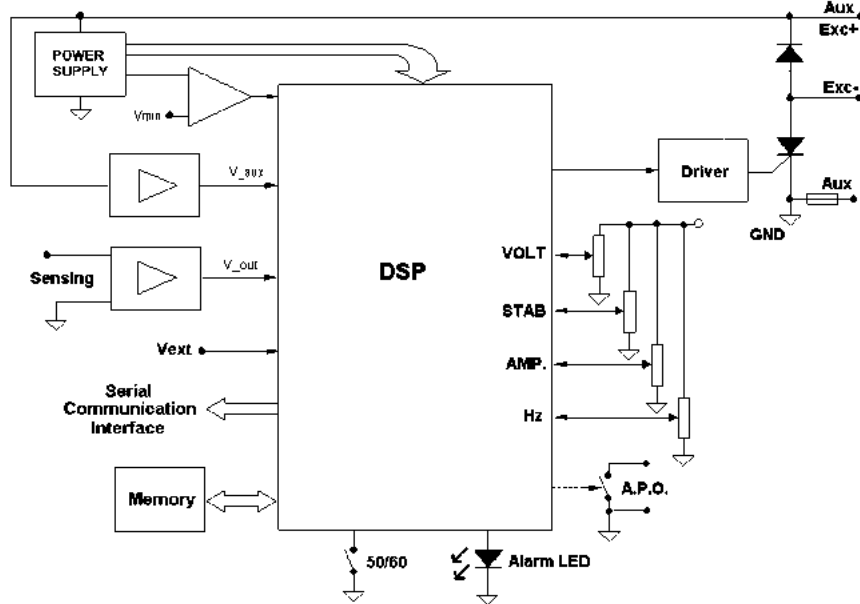

fig. 1

## INSTALLATION

Upon receipt of the digital regulator, perform a visual inspection to ensure that no damage has been sustained during transportation and movement of the equipment. In the event of damage, advise the shipper, the insurance company, the seller or Mecc Alte immediately. If the regulator is not installed immediately, store it in its original packaging in a dust and humidity-free environment.

The regulator is normally installed in the generator terminal box. It is fixed with two M4x20 or M4x25 screws and must be installed in a location where the temperature does not exceed the environmental conditions foreseen. The regulator is equipped with a 5A fast-acting protection fuse. If necessary, the fuse must be replaced only with a fuse of the same type and rating.

### 1. Overall dimensions drawings

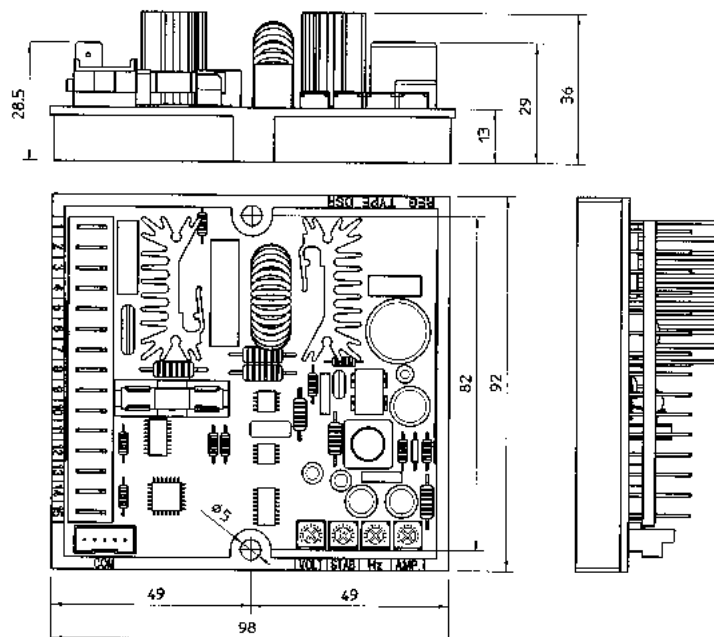

dimensioni in mm

fig. 2

## 2. Connections

The digital regulator connections depend on the application and excitation system.

Figure 1 shows the functional aspect of the connection points to the regulator.



An error in connection may have serious consequences for the unit.

Carefully check to make sure that all connections are precise and in accordance with the attached drawings, before turning on the power.

## 3. Terminals

Figures 2 show the connection terminals; the connections must be made using cables having a minimum diameter :

- for power cables on terminals 1, 2, 3 and 9 (Exc-, Aux/exc+, Aux): **1,5 mm<sup>2</sup>**
- for signal cables: **0,5 mm<sup>2</sup>**

## 4. DSR connections for typical applications

Drawings SCC0059/03, SCC0060/02, SCC0061/02, SCC0062/02, SCC0063/02, SCC0064/02 show DSR regulator connections for typical applications.

Drawing SCC0059/03 shows the connection to Series 3 alternators with 6 terminals.

Drawing SCC0060/02 shows the connection to Series 3 alternators with 12 terminals.

Drawing SCC0061/02 shows the connection to alternators with 6 terminals with reference from 140V to 280V. Drawing SCC0062/02 shows the connection to alternators with 12 terminals, with reference to the half phase from 70V to 140V.

The SCC0062/02 diagram shows the connection to 12-terminal alternators with reference to half phase from 70V to 140V. The SCC0063/02 diagram shows the connection to 12-terminal alternators for connections in series star or series delta with reference to the entire phase from 140V to 280V. The SCC0064/02 diagram shows the connection to 12-terminal alternators with reference to half phase from 140V to 280V.

## 5. Setting up the regulator

Selection of the sensing scale takes place directly according to the connection on the power terminal board; additional settings can be made with 4 trimmers (VOLT, STAB, AMP and Hz) and 3 jumpers (50/60Hz, JP1 and JP2); the output voltage can also be set with an external analogical or numeric signal; additional settings are available by adjusting 25 parameters stored in an integrated non-volatile memory.

### 5.1 Alternator voltage signals

Terminals 4, 5, 6, 7 and 8 of connector CN1 are used for voltage sensing.

### 5.2 Calibrating sensing

A supplementary calibration may be necessary to compensate for any existing tolerances on analogical voltage acquisition channels; in this case follow the procedure illustrated below:

1. Write **16384** on location 19 (from **Settings/Advanced**<sup>(1)</sup> Menu)
2. Disable the Trimmers (from the **Settings/Potentiometers**<sup>(1)</sup> Menu)
3. Disable Vext (from the **Settings/Advanced**<sup>(1)</sup> Menu)
4. Set the adjustment on the average or effective value (from the **Settings/Advanced**<sup>(1)</sup> Menu)
5. Measure the voltage with a suitable instrument for the type of adjustment made (average value or rms value)
6. Set the value at location 5 (or 6) until the voltage value, measured with the instrument, reaches 210 V (if the sensing is connected to terminals 4 or 5) or 105V (if the sensing is connected to terminals 6 or 7), keeping in mind that an increase in the value set provokes an increase in adjusted voltage and viceversa.
7. In order to ensure that the value of voltage (available also at location 36) is the same as the value measured at point 6, calibrate the data at location 7, reading the value of Volt box in the "status" area of **Settings/Advanced**<sup>(1)</sup> Menu.
8. Enable the trimmers you want to be active (from the **Settings/Potentiometers**<sup>(1)</sup> Menu)
9. Enable Vext (from the **Settings/Advanced**<sup>(1)</sup> Menu) if you want to be active

### 5.3 50/60 Signal

A jumper is located on the 50/60 input (connector CN1, terminals 12 and 13); if enabled from the **Configuration** Menu, it provokes the commutation of the underspeed protection threshold from 50·(100%-αHz%) to 60·(100%-αHz%), where αHz% represents the position relative to the Hz trimmer or the percentage value entered in location 21 (where 10% corresponds to 16384).

Note <sup>(1)</sup>: Software DxR Terminal

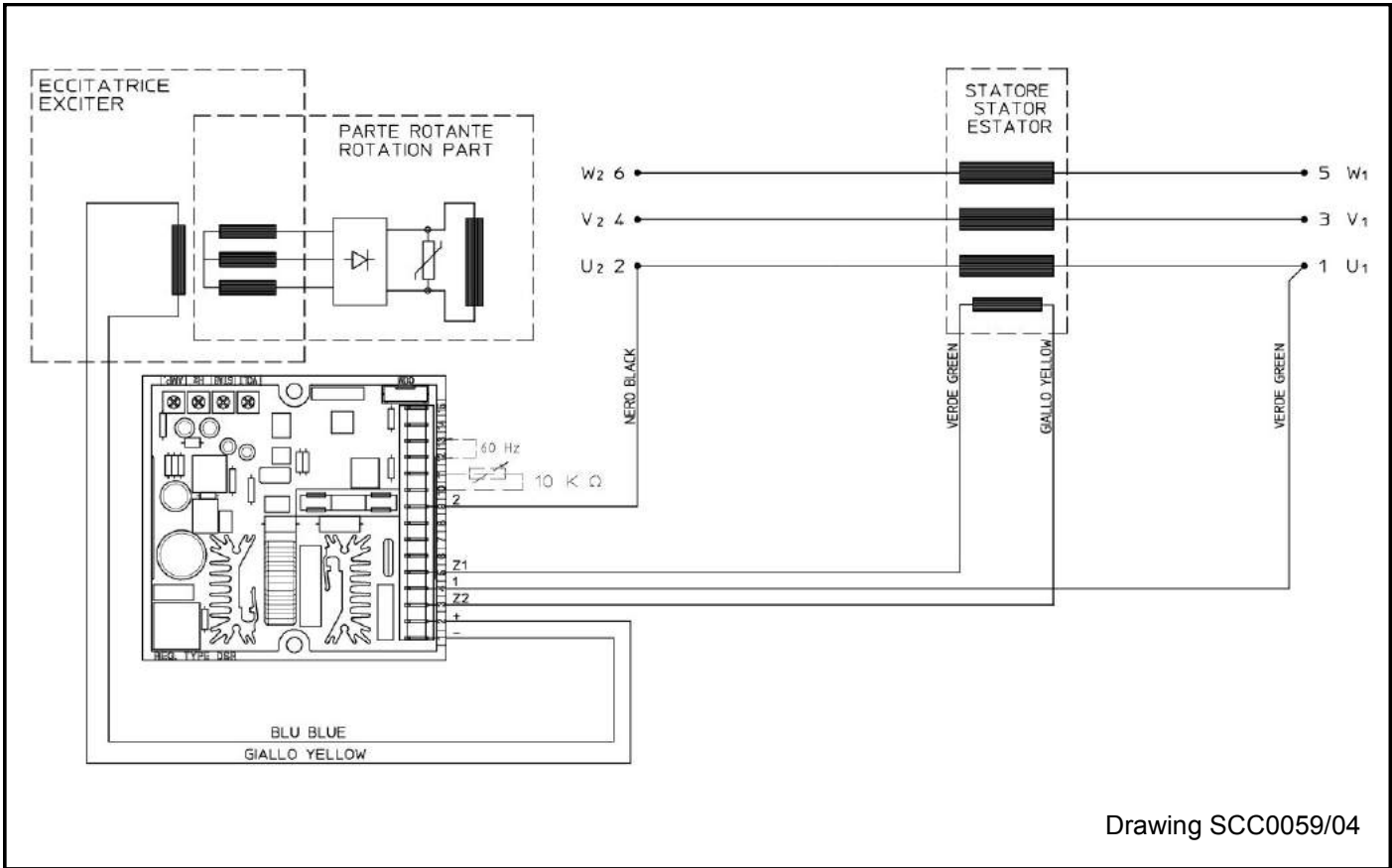

Series 3 alternators with 6 terminals  
Reference from 140V to 280V

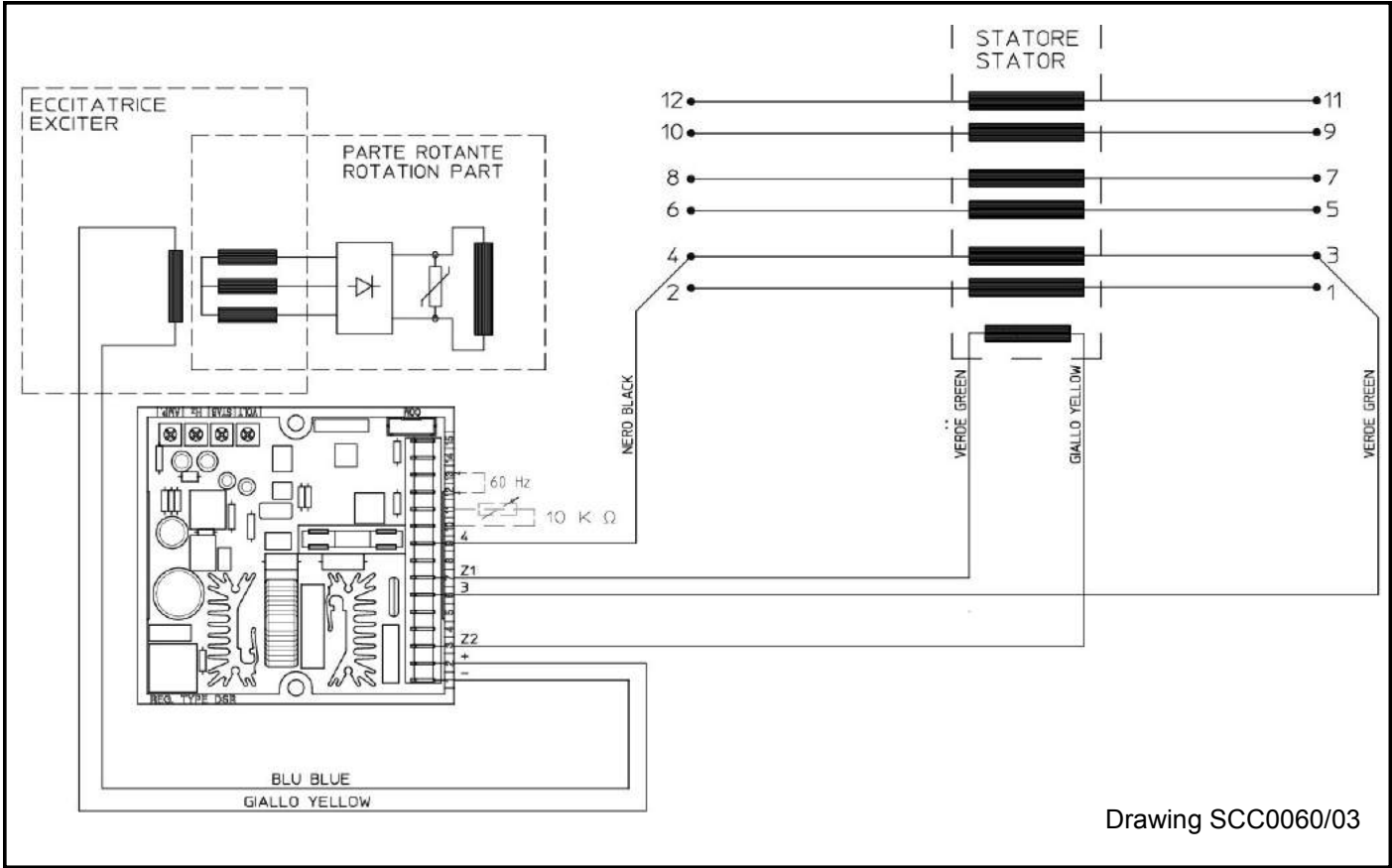

Series 3 alternators with 12 terminals  
Reference from 70V to 140V



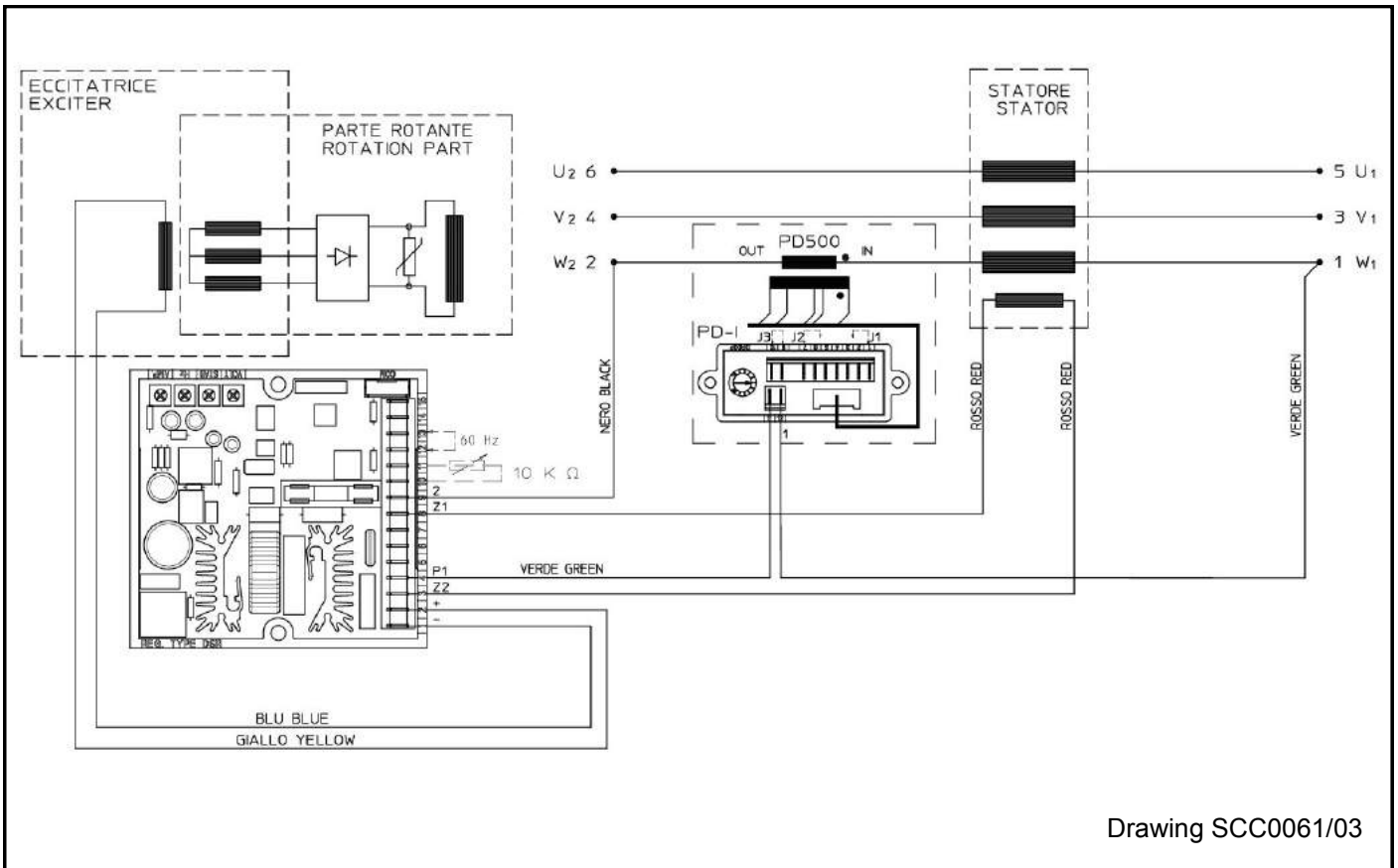

Series ECO alternators with 6 terminals  
Reference from 140V to 280V

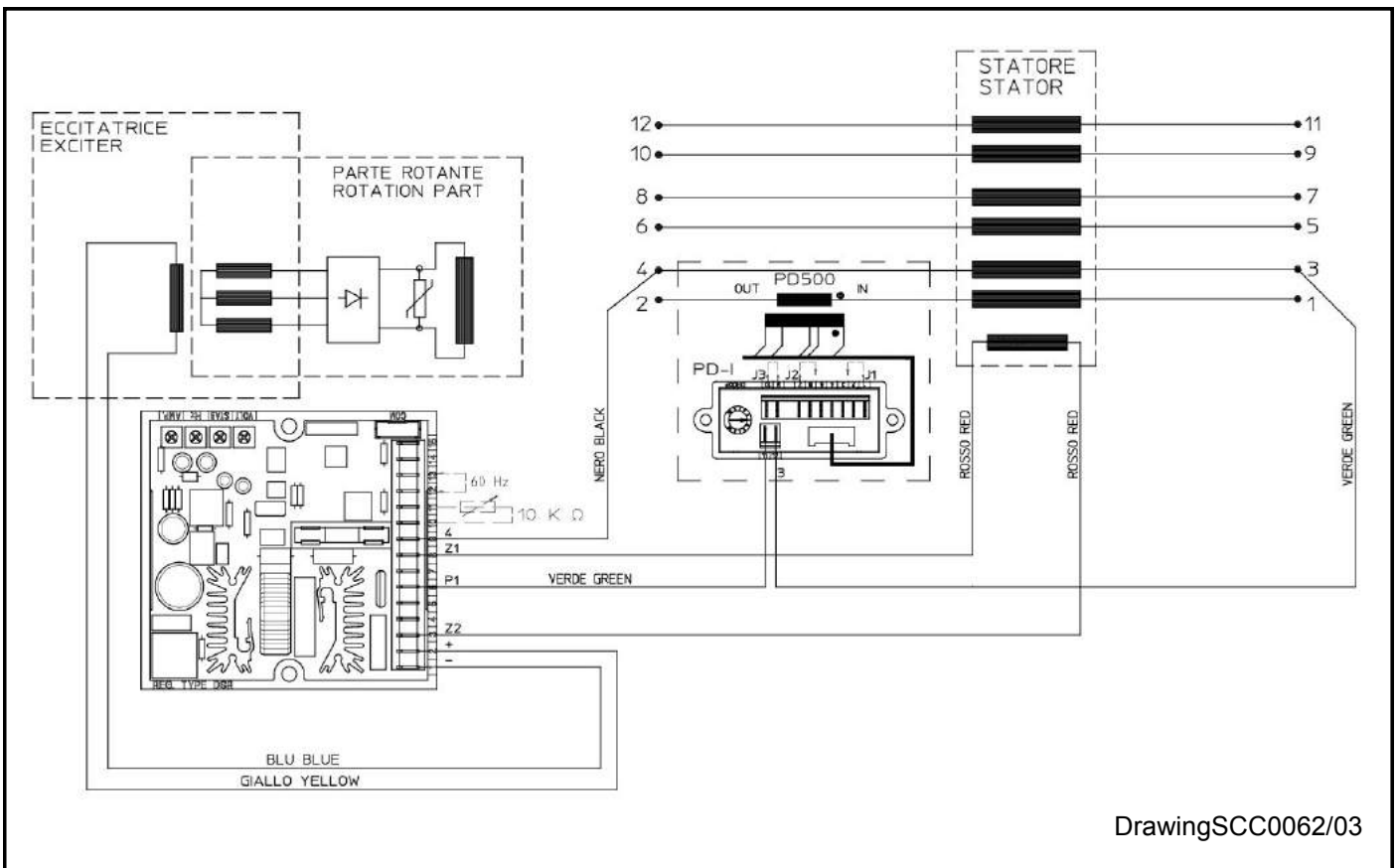

Alternators with 12 terminals, with reference on half phase, from 70V to 140V

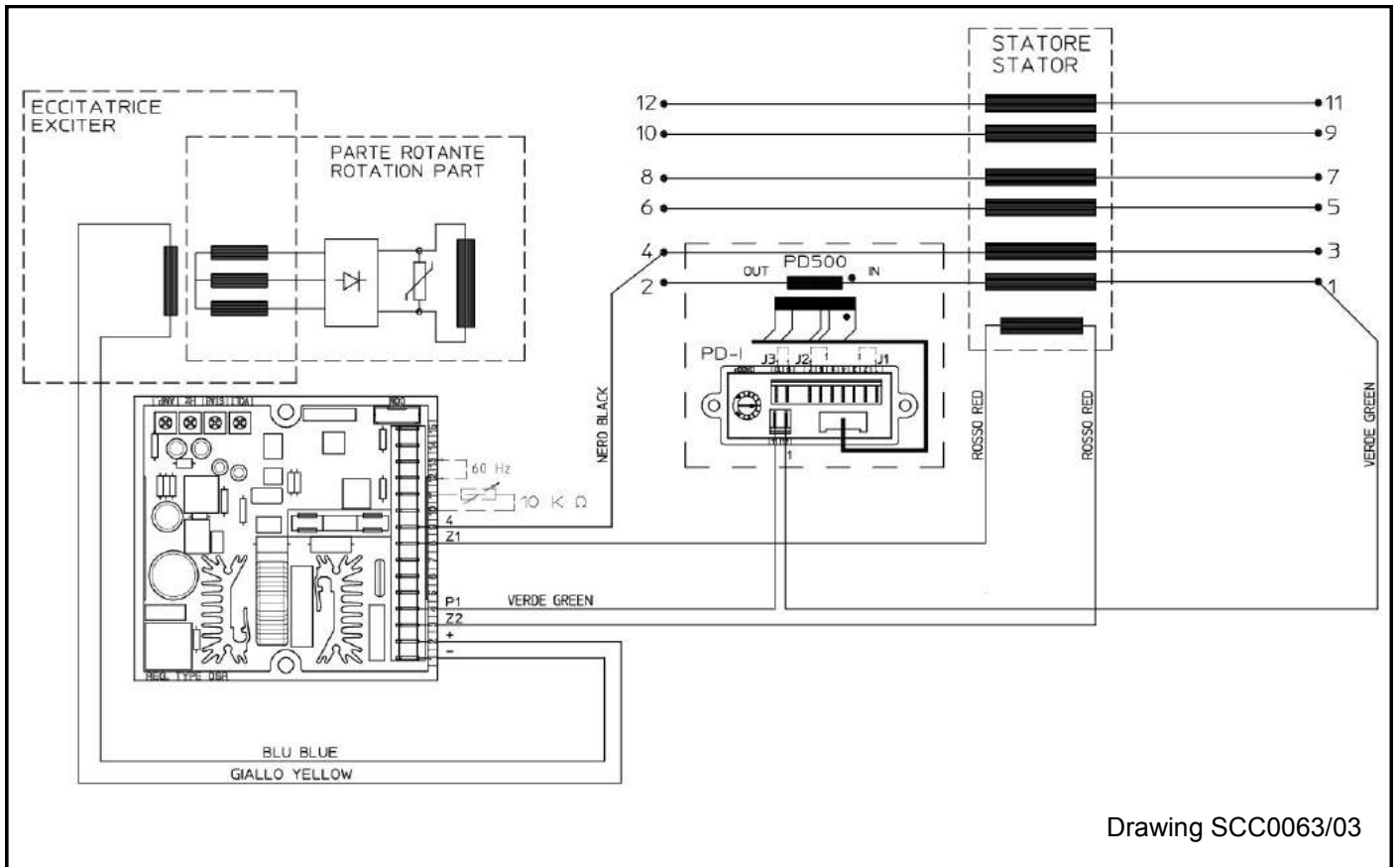

Alternators with 12 terminals, with reference on entire phase from 140V to 280V

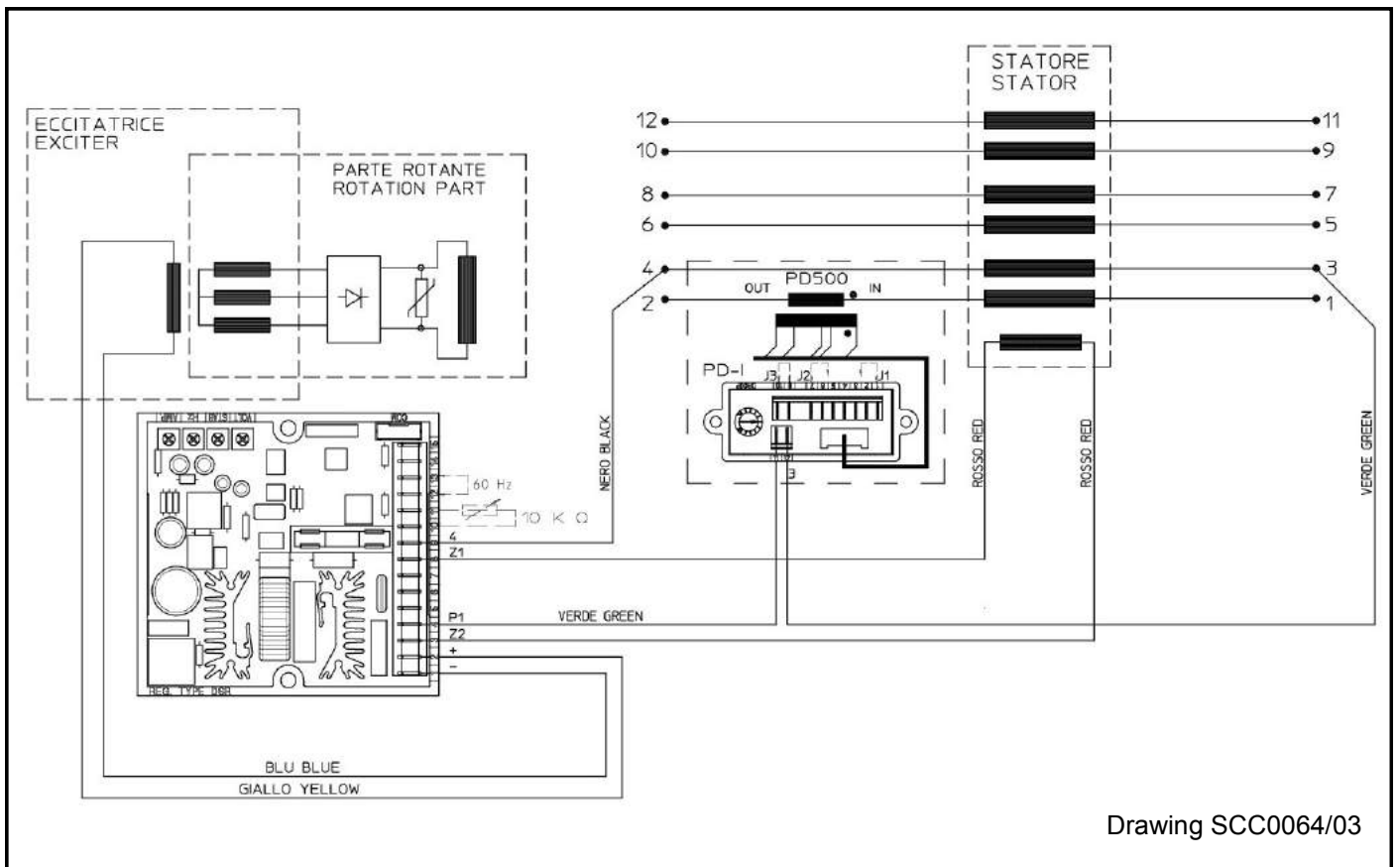

Alternators 12 terminals, with reference on half phase from 140V to 280V

## 6. Serial communications

The communication module USB2DxR (provided to be connected on the COM connector of the DSR) has a USB port through which it is possible to set the parameters (both for configuration and operation) and "monitor" the operation of the generator.

## 7. APO Contact

Acronym for Active Protection Output: (connector CN1 terminals 14 and 15) 30V-100mA non-isolated open collector transistor, normally closed if the "APO Invert" flag <sup>(2)</sup> is active (default), opens (with a configurable delay from 1 to 15 seconds) when, of all the alarms, one or several separately selectable alarms are active.

## 8. VOLT, STAB, Hz and AMP Trimmers

The trimmers are enabled by default, they can be disabled by the DxR\_Terminal software; if they are not enabled they do not perform any function.

The **VOLT** trimmer allows adjustment from about 70V to about 140V or from about 140V to about 280V.

The **STAB** trimmer adjusts the dynamic response (statism) of the alternator under transient conditions.

The **Hz** trimmer allows a variation up to - 20% with respect to the nominal speed value set by jumper 50/60 (if it is active) or from box 50/60 of the **Settings/UFLO&LAM** Menu (at 50 Hz the threshold can be calibrated from 40 Hz to 50 Hz, at 60 Hz the threshold can be calibrated from 48 Hz to 60 Hz).

The **AMP** trimmer adjusts the excitation overcurrent protection intervention threshold.

## 9. Vext Input

The Vext input (connector CN1 – terminals 10 and 11) permits analogical remote control of output voltage through a 10Kohm potentiometer with a programmable variation range through parameter 16 with respect to the value set (by default the setting is  $\pm 14\%$  <sup>(3)</sup> starting from revision 10 of the Firmware); if you want to use continuous voltage <sup>(4)</sup>, it will be effective if it is in the range between 0V and +2,5V. The input tolerates voltages from -5V to +5V, but for values exceeding the limits of 0V / +2,5V (or in the event of disconnection), two options are possible: not to take the set point of external input (default configuration) and return to regulation to the voltage value set with the trimmer (if enabled) or with parameter P[19], or keep the minimum (or maximum) value of voltage that can be reached (see figures 3a and 3b). The two options can be set with the **RAM Voltage CTRL** flag in the **Settings/Advanced** menu corresponding to the bit B7 of the configuration word P[10] (see PARAMETERS AND OPERATIONAL DATA - Para. 2). The setting relative to the Vext input are summarised in table 5.

### Relationship between analogical input (Vext) and output voltage (Vo)

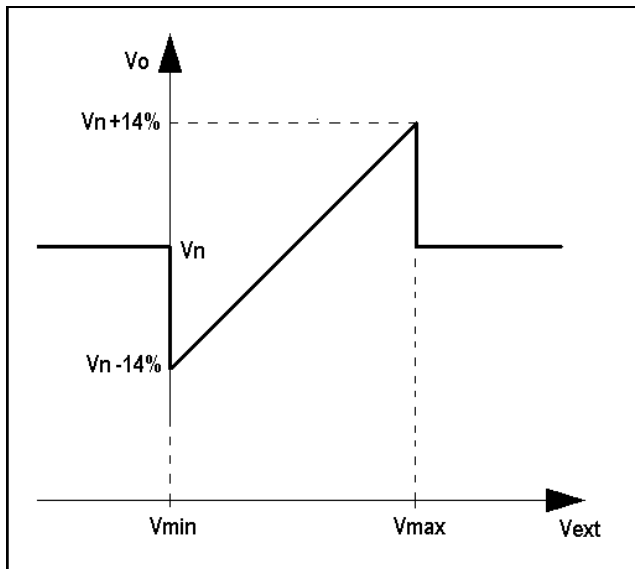

Figure 3a: without saturation of the output voltage upon reaching the input voltage limits

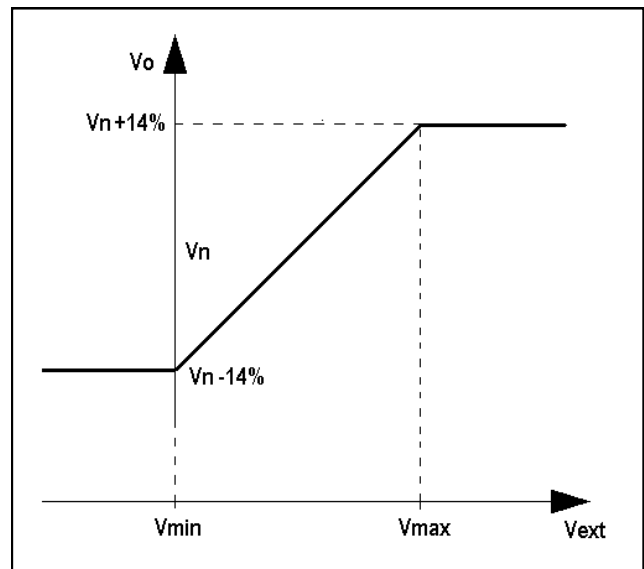

Figure 3b: with saturation of the output voltage upon reaching the input voltage limits

**NOTE** <sup>(1)</sup>: Software DxR Terminal

**NOTE** <sup>(2)</sup>: Starting from rev. 18 of the Firmware, if the "APO Invert" flag is not active or for firmware revisions up to 17 the transistor is normally open and it closes in case of an active alarm

**NOTE** <sup>(3)</sup>: In making adjustments it is recommended not to exceed the nominal value of voltage of the alternator beyond  $\pm 10\%$ .

**NOTE** <sup>(4)</sup>: the source of DC voltage must be capable of absorbing at least 2 mA.

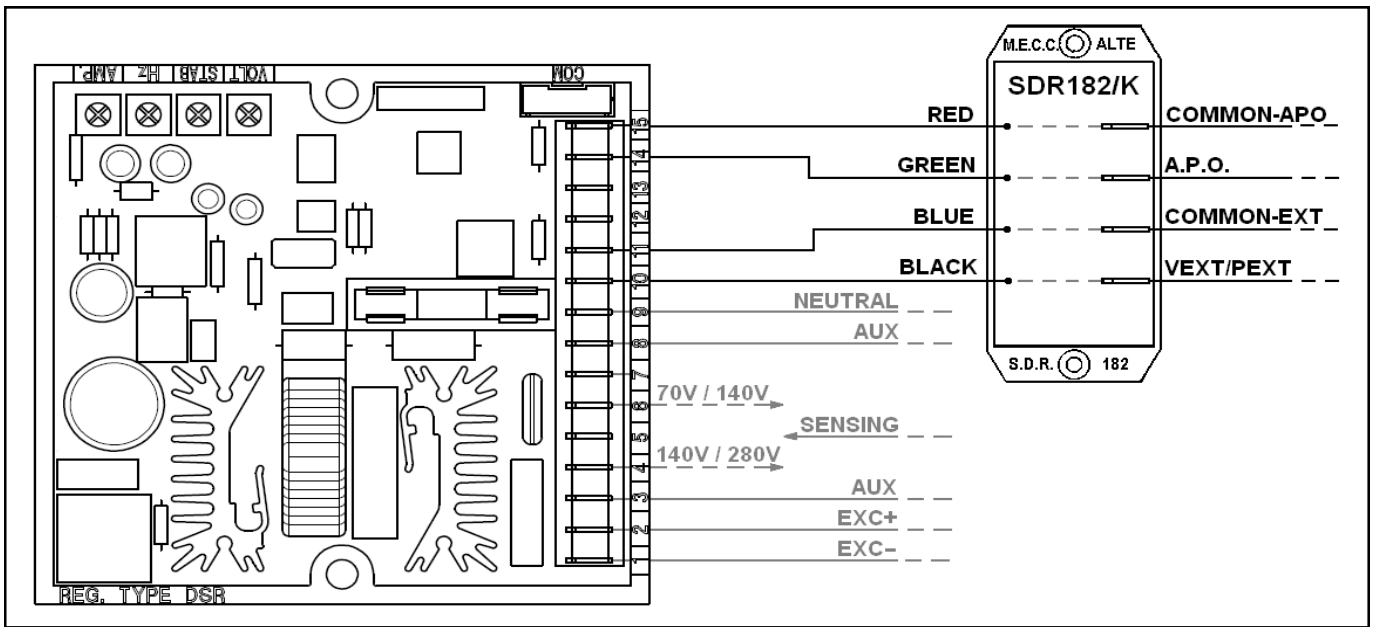

Fig. 4: EMI SDR182/K filter connection

## SERIAL CONNECTION

The COM connector is reserved for the connection to the USB2DxR communication module through the dedicated cable provided together with the module.

For the communication, the regulator implements a subsystem of the ModBus standard; the DSR-USB2DxR system performs a "slave" operation the address of which is stored in the DSR EEPROM and is set during configuration.

Detailed descriptions of the ModBus commands implemented are into the Technical Guide "Digital Regulators Communication Protocol" available on the web site [www.meccalte.com](http://www.meccalte.com)

The "Master Unit" is made up of a PC or other dedicated equipment and can access the parameters and functions of the regulator.

The master unit has the following possible functions:

- Repetition, or visualisation, of the generator status variables, even from a remote location
- Setting of single parameters
- Uploading and downloading of settings files
- Status readings (alarms, measuring variables)
- Readings of the alarm memory information
- Interface conversion towards other field buses or communications networks.

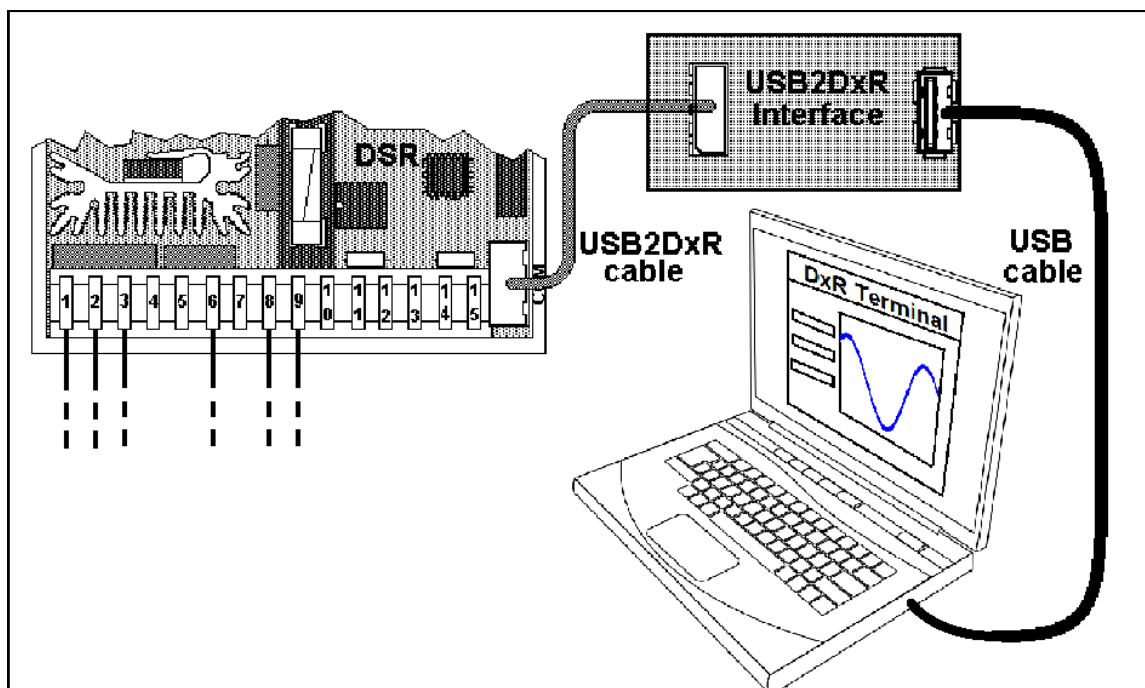

Fig. 5: Connection between DSR and PC through USB2DxR digital interface

## PARAMETERS AND OPERATING DATA

### 1. ModBus Registry List

An EEPROM memory is used to store configuration parameters and other information that must not be lost when the generator goes off. Parameters can be read/written and machine operational settings entered through USB (using USB2DxR module). Two versions of this regulator are available: DSR and DSR/A; they differ mainly in the default parameters. Table 3 shows a complete list of the parameters that can be set, which define all the operational conditions of the regulator.

**TABLE 3 : EEPROM SETTING REGISTRIES**

Add.	Description of Parameter	Range	Default		NOTES
			DSR	DSR/A <sup>(1)</sup>	
0	Firmware revision	0..65535	18	18	Reserved - Do not write
1	ModBus slave address	1..31	1	1	Identification of RS485 network (or broadcast)
2	Software configuration	0..65535	18	2706 <sup>(2)</sup>	Reserved - Do not write
3	Serial number, high part	16bit	0	0	Reserved - Do not write
4	Serial number, low part	16bit	0	0	Reserved - Do not write
5	RMS sensing calibration	0..32767	16384	16384	Calibration of voltage channels in 3 ph adjustment
6	AVG sensing calibration	0..32767	16384	16384	Calibration of voltage channels in 1 ph adjustment
7	Measured voltage calibration	0..32767	16384	16384	Calibration of location L 36 (first "STATUS" box)
8	Current limit time <sup>(3)</sup>	0..32767	0	0	Duration of limiting in number of periods <sup>(3)</sup>
9	Current limit level <sup>(3)</sup>	0..32767	32767	32767	Excitation voltage limit upon start-up <sup>(3)</sup>
10	Word configuration	16bit	7997	7997	Detailed description in paragraph 2 Tab. 4
11	Shift to LEFT proportional gain	0..6	4	5	n=0...6 is equivalent to a multiplication by 2 <sup>n</sup>
12	Shift to LEFT integral gain	0..6	3	1	
13	Coefficient tying Ki to Kp	0..32767	16384	26624	Coefficient to set Ki and Kp separately
14	Vout / Vaux Ratio	±32767	6000	6000	Limit to voltage reduction as a function of frequency
15	Reference equivalent to Vext	0..32767	16384	16384	Value used if the Vext input and location L[49] are disabled <sup>(3)</sup>
16	Limitation of Vext Variation	0..6553	4608	4608	Limits the effect of external analogical input (0->0; 4608->14%)
17	APO delay & alarm settings	0..65535	254 <sup>(4)</sup>	254 <sup>(4)</sup>	APO activating alarms selection and delay settings
18	Step limitation reference	1..1000	20	20	For rapid variations of voltage setpoint, the passage from one value to another takes place through added or subtracted steps at each period.
19	Vout Reference	0..32767	0	0	Value used if the VOLT trimmer is disabled
20	Stability	0..32767	16384	16384	Value used if the STAB trimmer is disabled
21	Freq. threshold ± 10% freq <sub>nom</sub>	0..32767	16384	16384	Value used if the Hz trimmer is disabled
22	Excitation overcurrent threshold	0..32767	16384	16384	Value used if the AMP trimmer is disabled
23	V/F Slope	0..32767	9000	9000	V/F curve slope during normal operation
24	V/F curve slope at start up	0..32767	12000	12000	Used only upon start up
25	Short circuit time	0..255	20	20	Operating time with short circuited alternator, expressed in tenths of seconds (0 ..... 25.5 seconds) [0=excluding STOP]
26	Overspeed threshold	±32767	0	0	Variation (±10%) of overspeed alarm intervention with respect to the default value of 55/66Hz
27	Underexcitation threshold <sup>(4)(5)</sup>	0..32767	512	512	Under-excitation alarm threshold (4)
28	Ki Overexcitation regulator	0..32767	12287	12287	Integral gain of excitation voltage regulator
29	AMP slope (f) <sup>(4)(6)</sup>	0..32767	15154	15154	AMP (f) <sup>(4)(6)</sup> overexcitation protection slope
30	Thermal dispersion coefficient	0..65535	63600	63600	Used by AMP alarm temperature estimator
31	Reserved	0..65535	-	-	Do not write

NOTE: Locations are ordered to separate the parameters of individual regulators (S.N., SW versions and calibration) from settings foreseen, in order to facilitate programming of regulators with the same settings but different S.N., SW versions and calibrations. The parameters from 0 to 9 are adjusted at the factory for each regulator. The parameters from 10 to 30 can therefore be freely copied from one to another.

NOTE <sup>(1)</sup> starting from rev.10 of the Firmware

NOTE <sup>(2)</sup> starting from rev.15 of the Firmware, 2578 in previous versions

NOTE <sup>(3)</sup> starting from rev.15 of the Firmware

NOTE <sup>(4)</sup> Starting from rev. 18 of the firmware

NOTE <sup>(5)</sup> Shutdown intervention threshold not to be changed in the versions preceding the 18<sup>th</sup>

NOTE <sup>(6)</sup> Proportional gain of excitation voltage regulator in the versions preceding the 18<sup>th</sup>

## 2. Configuration word (Parameter P[10])

The configuration of the regulator is performed by setting the individual bits of parameter P[10]; every one of them enables or disables at least one function based on the fact that its value is, respectively, either 1 or 0. If the "DxR Terminal" software is used (see Technical guide "Interface communication USB2DxR"), the setting is simplified by the use of the dedicated flags in the different menu corresponding to the specific bit, which enables/disables each function.

Alternatively, the DSR may be configured by directly setting the value of the P[10] parameter; in such case the value is calculated before the writing, by summing the numbers specified in the "Value" column of Table 4 corresponding to the functions that you want to enable.

For example the default configuration demands that the bits B0, from B2 to B5 and from B8 to B12 be enabled; therefore, the corresponding value is:  $P[10]=1+4+8+16+32+256+512+1024+2048+4096=7997$ .

**TABLE 4 : BIT FUNCTION OF THE CONFIGURATION WORD (PARAMETER P[10] )**

Bit	Value	Function	Default
B0	1	RMS regulation	1
B1	2	Periodical reference variation	0
B2	4	Automatic voltage offset compensation	1
B3	8	Voltage measurement by last 32 samples	1
B4	16	Enable hardware jumper 50/60Hz	1
B5	32	Inversion APO <sup>(3)</sup>	1 <sup>(3)</sup>
B6	64	Not used	0
B7	128	External location reference L[49] <sup>(1)</sup> and activation of saturation in the event of overflow <sup>(2)</sup>	0
B8	256	Enable VOLT TRIMMER	1
B9	512	Enable STAB TRIMMER	1
B10	1024	Enable Hz TRIMMER	1
B11	2048	Enable AMP TRIMMER	1
B12	4096	Enable external analogical input	1
B13	8192	Enable external DAC	0
B14	16384	60 Hz setting in the event of disabling of the 50/50 Hz hardware jumper	0
B15	32768	Reserved	0

NOTE (1): if analogical input is disabled, starting from rev.15 of the Firmware

NOTE (2): for analogical input, starting from rev.15 of the Firmware

NOTE (3) Starting from rev. 18 of the firmware, default value 0 in the preceding versions

## 3. RAM location reference, activation of saturation in analogical remote control

The RAM Voltage CTRL Flag (corresponding to bit 7 of the P[10] configuration word) performs two functions:

1. If the Pext hardware input is enabled (Flat Ext. Input corresponding to bit 12 of the P[10] configuration word), the **RAM Voltage CTRL Flag** activates saturation of output voltage when the analogical control voltage reaches the limit foreseen for input, to which it is applied (see Para. 8 Remote control of voltage).



If saturation is enabled, in the event of removal of the Vext/Pext connection (due to accidental opening, for example) the voltage goes to the maximum value set in parameter P[16] (+14% by default).

2. When hardware input Pext is disabled, the indicated flag defines the value to be used by the software control of the output voltage. If **RAM Voltage CTRL** is deactivated (B7=0), the non volatile parameter P[15] is used (therefore following shut down and restart of the regulator, the last value memorised remains set): on the start up the location L[49] is initialised with the value of parameter P[15] and is kept aligned to that value. Editing of location L[49] has no effect in this working condition. If **RAM Voltage CTRL** is active (B7=1) the volatile location L[49] is used for software remote control of the output voltage (when the regulator is energized, the value is stored; if the regulator is shut down, the value is lost). This function is particularly useful for the applications of alternators in parallel with grid, when the regulation of the reactive power exchanged is controlled by means of a third party supplied digital supervisor.

**TABLE 5 : REMOTE VOLTAGE CONTROL FLAGS FUNCTION**

FLAG RAM Voltage CTRL	P[10] Bit B7	FLAG Ext. Input	P[10] Bit B12	Output voltage control type
<input type="checkbox"/>	0	✓	1	Analogical without saturation
✓	1	✓	1	Analogical with saturation
<input type="checkbox"/>	0	<input type="checkbox"/>	0	Digital - Parameter P[15]
✓	1	<input type="checkbox"/>	0	Digital - Location L[49]

#### 4. Volatile memory addresses

TABLE 6 : VOLATILE MEMORY ADDRESSES				
Addr.	Add name	Range	Access	Description
32	VOLT Trimmer	0..32767	Read only	VOLT Trimmer Position
33	STAB Trimmer	0..32767	Read only	STAB Trimmer Position
34	Hz Trimmer	0..32767	Read only	Hz Trimmer Position
35	AMP Trimmer	0..32767	Read only	AMP Trimmer Position
36	First status word	0..3200	Read only	Regulated voltage [tenths of volts]
37	Second status word	0..900	Read only	Frequency [tenths of Hz]
38	Third status word	16bit	Read only	Active alarms
39	Fourth status word	16bit	Read only	Active configuration
40	Commands	16bit	Write	Reserved Word Commands – Do not use
41	Pext/Vext Inputs	0..32767	Read only	Analogical input or external potentiometer value
42	Setpoint	0..32767	Read only	Setpoint value
43	Setpoint	0..32767	Read only	Value modified by regulator in case of alarms, soft-start, etc.
44	Measured Voltage	0..32767	Read only	Internal variable
45	Estimated temperature	0..32767	Read only	Estimates temperature of exciter windings
...	...			...
49	Reference corresponding to Vext	0..32767	Write	Used if Vext input is disabled and voltage remote control by RAM location is enabled (P[10]-Bit B7=1)
...	...			...
53	Kp/2 <sup>P[11]</sup>	0..32767	Read only	Proportional gain not considering factor 2 <sup>P[11]</sup> ( <sup>1</sup> )
54	Ki/2 <sup>P[12]</sup>	0..32767	Read only	Integral gain not considering factor 2 <sup>P[12]</sup> ( <sup>1</sup> )
55	AMP protection threshold	0..32767	Read only	Intervention threshold of overexcitation protection ( <sup>1</sup> )
56	Underexcitation observer	0..32767	Read only	Observer of underexcitation or loss of excitation ( <sup>2</sup> )

#### 5. Fourth Status Word (Location L[39])

Location L[39] indicates (almost in real time) the active configuration at any given time.

The values of the fourth word of status (location L[39]) are shown in table 7, on the basis of the most common types of regulation and nominal frequency.

TABLE 7 : STANDARD VALUES OF THE FOURTH STATUS WORD (LOCATION L[39])		
Regulation	Rated frequency:	
	50Hz	60Hz
RMS	7997 <sup>(2)</sup>	24365 <sup>(2)(3)</sup>
AVG + no offset compensation + 64 samples	7984 <sup>(2)</sup>	24352 <sup>(2)(3)</sup>

TABLE 8 : BIT FUNCTION OF THE FOURTH STATUS WORD L[39] (ACTIVE CONFIGURATION)			
Bit	Function	Value	Default
B0	Active RMS Regulation	1	1
B1	Bit activating a periodical variation of reference voltage	2	0
B2	Bit activating automatic compensation of the offset in voltage acquisition channels	4	1
B3	Voltage measurement by last 32 samples	8	1
B4	Bit enabling reading of 50/60 Hz jumper hardware	16	1
B5	Free for future use	32	1
B6	Not used	64	0
B7	Voltage remote control by RAM location L[49] or input saturation ( in case of overflow )( <sup>1</sup> )	128	0
B8	Bit enabling reading of reference voltage by VOLT Trimmer	256	1
B9	Bit enabling reading of stability parameter by STAB Trimmer	512	1
B10	Bit enabling reading of underspeed protection threshold by Hz Trimmer	1024	1
B11	Bit enabling reading of excitation current threshold by AMP Trimmer	2048	1
B12	Bit enabling reading of external voltage input	4096	1
B13	Bit enabling DAC	8192	0
B14	60Hz Setting enabled (effective only if L[38]-Bit4 = P[10]-Bit4 = 0) <sup>(3)</sup>	16384	0
B15	Reserved	32768	0

NOTE <sup>(1)</sup> starting from rev.15 of the Firmware.

NOTE <sup>(2)</sup> starting from rev. 18 of the firmware

NOTE <sup>(3)</sup> software configuration, with the 50/60 jumper disabled

# IMPOSTAZIONE DEI PARAMETRI VOLT, STAB, AMP Hz.

## 1. Voltage

### 1.1 Setting voltage

The measurement of the true RMS value or of the average value depends on the value of the 0 bit of parameter 10, adjustable in Configuration in the Settings/Advanced menu of the DxR Terminal software as well.

The voltage setting may take place through the trimmer or software; the sensing input range on CN1-6 and CN1-7 is 70÷140 Vac; the sensing input range on CN1-4 and CN1-5 is 140÷280 Vac.

There are two ways to set the value from the minimum to the maximum:

1. Through the VOLT trimmer which must be enabled in the Settings/Potentiometers menu of the DxR Terminal software
2. Through parameter 19 (the Volt trimmer must be disabled from the Settings/Potentiometers menu: 0 value corresponds to the minimum voltage, 16382 corresponds to the intermediate value (respectively 105V and 210V), 32767 corresponds to the maximum voltage.

For standard voltage values refer to table 9.

Voltage CN1 4&5	Voltage CN1 6&7	Volt Trimmer (Location 32)	Parameter 19
173	-	7724	7724
-	127	26683	26683
200	100	14043	14043
208	104	15916	15916
220	110	18725	18725
230	115	21065	21065
240	120	23406	23406
266	133	29491	29491
277	138,5	32066	32066

Voltage may also be varied through the Vext input (connector CN1-10 and 11) if it is enabled in the Pext/Vext area of the Settings/Advanced menu, through a 10Kohm potentiometer with a programmable variation range of up to ±100% (parameter 16; the default setting is ±14%, even if it is convenient do not exceed more than ±10%), or through a continuous voltage, which will be effective if it is in the range between 0V and +2,5V, or even through parameter P [15] or location L[49] (if the Vext input is disabled). For additional details see the paragraph "Remote control of voltage".

### 1.2 Soft Start (starting from rev.15 of the Firmware)

In the event of fast start up of the prime mover or sudden regulator switching on, with generator running at nominal speed, to guarantee the nominal voltage the excitation current should quickly change and therefore it could happen an engine braking effect or temporary generator overvoltage.

These effects may be minimized by adequately setting the "Delay" and "Excitation limit" parameters in the "Soft-Start area of the Settings/Advanced menu corresponding to parameters P[8] and P[9]: during start up, the above-mentioned settings determine a limit to the excitation current.

Parameter P[8] sets the duration of the excitation current limitation, namely the value of the parameter corresponds to the number of periods in which the limitation is active. The default value is P[8]=0 which corresponds to deactivation of the soft start. Considering that in most cases the alternator is already at nominal speed, an estimate in terms of time (corresponding to the "Delay" setting in the Soft-start area) for 4 pole machines, may be deduced using the following formula:

$$t_{lim} = P[8] \cdot \frac{1}{f_n} = P[8] \cdot \frac{30}{\omega_n} \quad \text{Where } f_n = \text{nominal frequency in Hz or } \omega_n = \text{nominal speed in R.P.M}$$

The parameter P[9] sets the excitation current limit: the value P[9]=0 corresponds to zero excitation current, while the maximum value P[9]=32767 corresponds to no limits on the current limitation. The default value is P[9]=32767. When the interval of action of the soft start has been exceeded, the output voltage moves to the value set. The rapidity of the change is set by parameter P[18] (see paragraph on "Slow voltage variations")



The optimal value of "Delay" and "Excitation limit" (parameters P[8] and P[9]) depends a lot on the alternator type and on the final application and it is determined by experimentation. An inappropriate setting may cause failure of the alternator to self-excite.

For example, for the ECO46 Series high power alternators, you can try the following settings: Delay=1280ms (P[8]=64) and Excitation limit=50% (P[9]=16384); for ECP3 series low power alternators you can experiment the effects of a reduction of both the duration and the current limit, for instance Delay=320ms (P[8]=16) and Excitation limit=3.72% (P[9]=4096)



## 1.2 Slow voltage variations

In the event of a reference rapid variation, due to a regulator sudden feeding, or remote voltage setting (through Vext analogic input or through serial) a procedure of "slow" variation has been foreseen: in response to a step variation, parameter P[18] determines the rapidity with which the transition is made. (see fig. 6)

A value of 1 involves the slowest possible variation; a value exceeding 100 involves an almost immediate variation. The value 0 disables any variation.

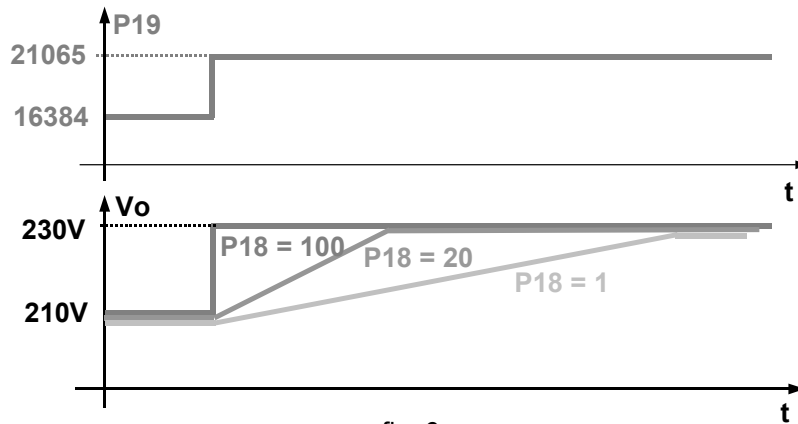

fig. 6

## 2. Stability

### 2.1 Stability regulation

The voltage regulator is of the proportional-integral type, the diagram is shown in fig. 7.

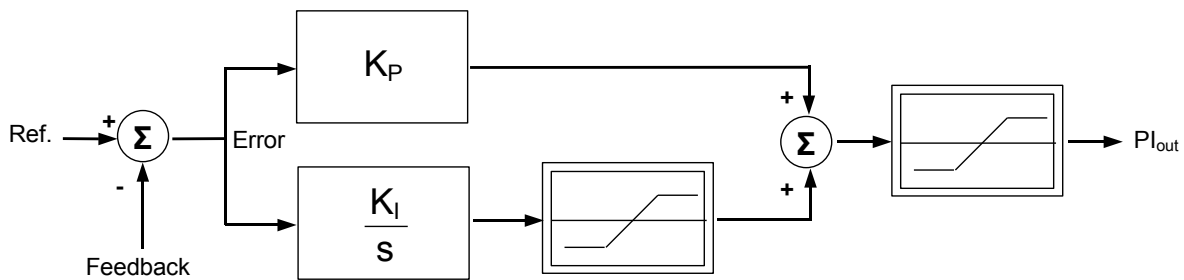

fig. 7: regulator diagram

The values of the proportional and integral gain ( $K_P$  and  $K_I$  respectively) depend on the position of the STAB trimmer if enabled, or the value of parameter P[20] if the trimmer is disabled. The value of the proportional gain  $K_P$  also depends on the value of the P[11] parameter. The value of the integral gain  $K_I$  depends on the values of parameters P[12] and P[13] and, only for the standard DSR (grey box) with the STAB trimmer enabled, even on the 50/60Hz<sup>(1)</sup> setting. In the other DSR versions, for example DSR/A (blue box), the integral gain  $K_I$  does not differ no matter how the 50/60Hz<sup>(4)</sup> setting is set.

The numeric elaborations carried out by the DSR for obtaining the proportional and integral gain values are given in the block diagrams in figures 7a<sup>(2)</sup>, 7b<sup>(2)</sup> and 7c.

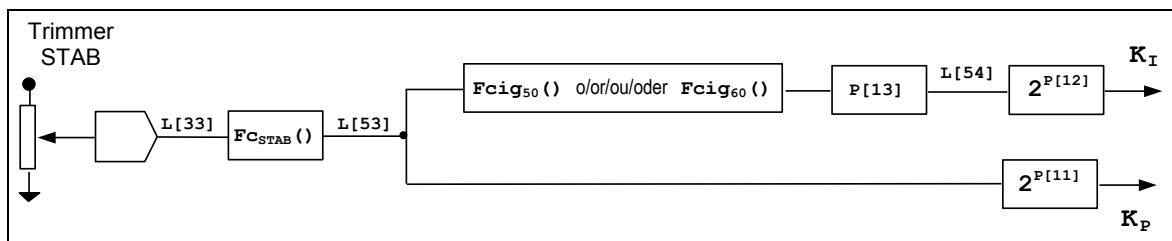

fig. 7a: drawing of the numeric elaboration of the proportional and integral gain by a DSR (standard) with the STAB trimmer enabled

If the STAB trimmer is enabled (STAB Flag Trimmer present) its angular position, available at location L[33], is transformed by the  $F_{C_{STAB}}^{(2)}$  function into the numeric value available at location L[53]<sup>(3)</sup> (figs. 7a and 7b). If the STAB trimmer is disabled, the value of location L[53]<sup>(3)</sup> directly becomes the value set using the P[20] parameter (fig. 7c). The proportional gain  $K_P$  is obtained by multiplying the value of location L[53]<sup>(3)</sup> by a coefficient that depends on the value given in parameter P[11]<sup>(4)</sup>.

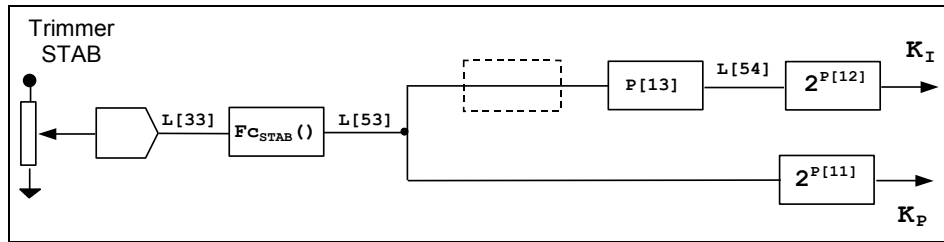

fig. 7b: drawing of the numeric elaboration of the proportional and integral gain by a DSR/A with the STAB trimmer enabled

The integral gain, available at location L[54]<sup>(3)</sup> minus the multiplication by a coefficient, depends on the value of the proportional gain at location L[53]<sup>(3)</sup>; in the standard DSR (grey box) with the STAB trimmer enabled (STAB Flag Trimmer present) the value of location L[53]<sup>(3)</sup> at 50Hz is transformed by the function  $F_{cig_{50}}^{(2)}$  and by the multiplication of the value of parameter P[13], in the numeric value available at location L[54]<sup>(3)</sup>; at 60Hz the transformation function is  $F_{cig_{60}}^{(2)}$ , different from that at 50Hz, (fig. 7a); in the other versions of the DSR (fig. 7b), for example DSR/A (blue box), or if the STAB trimmer is disabled<sup>(4)</sup> (fig. 7c), not only is there a difference between the integral value at 50Hz and at 60Hz, but even the value of location L[54]<sup>(3)</sup> is obtained by simply multiplying the proportional gain at location L[53]<sup>(3)</sup> by the value of parameter P[13].

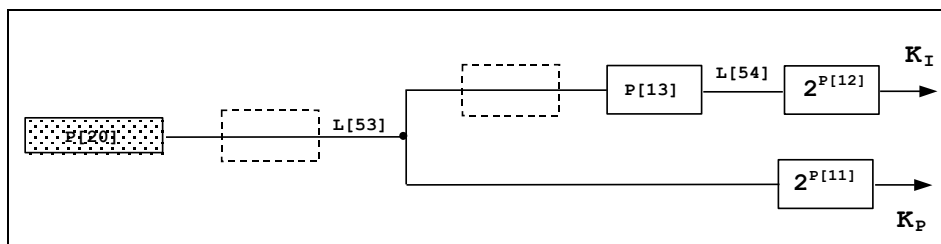

fig. 7c: drawing of the numeric elaborations of proportional and integral gain by all DSRs with STAB trimmer disabled

In both cases, the effective integral gain  $K_I$  is obtained by multiplying the value of location L[54]<sup>(3)</sup> by a coefficient that depends on the value given in parameter P[12]<sup>(4)</sup>.

The mentioned coefficients can take on values of 1, 2, 4, 8, 16, 32 or 64 according to the values written in parameters P[11] (for proportional gain) and P[12] (for integral gain); these values represent the value assigned to base 2 (fixed) to obtain the required coefficient (e.g. parameter P[11] = 4 => multiplication coefficient of the proportional gain =  $2^4 = 16$ , P[12] = 3 => multiplication coefficient of the integral gain =  $2^3 = 8$ ).

The following tables show, for every three-phase machine on 50Hz and 60Hz, the STAB trimmer calibration which allows increased speed of response to the transistor with the generator in stand-alone operation. In case of different applications (for example alternators reconnected in single-phase, in parallel among them or in parallel with the grid, with motors having less than 4 cylinders and so on) it may be necessary to readjust the STAB trimmer calibration.

If the voltage cannot be stably adjusted for permanent operation and/or in the transient by the STAB trimmer settings, it may be necessary to vary one or more stability adjustment parameters: P[11], P[12] and P[13] the description of which is given in table 3.

NOTE <sup>(1)</sup> Starting from Rev. 15 of the firmware

NOTE <sup>(2)</sup> The  $F_{C_{STAB}}$ ,  $F_{cig_{50}}$  and  $F_{cig_{60}}$  functions are not implemented in the DSRs with firmware up to version 14, and in the block diagram they are considered as identities, i.e.  $L[53]^{(3)} = F_{C_{STAB}}(L[33]) = L[33]$  e  $F_{cig_{60}}(L[53]) = F_{cig_{50}}(L[53]) = L[53]^{(3)}$ . With these regulators the STAB trimmer needs to be rotated by less than two notches counted clockwise.

NOTE <sup>(3)</sup> Location available to the user from firmware Rev. 15.

NOTE <sup>(4)</sup> Structure valid also for DSRs with firmware up to version 14 but without location L[53] and L[54] availability

**TABLE 10 ECO/ECP SERIES: ADVISED STAB TRIMMER SETTING ON DSR<sup>(1)</sup> Fw Rel. ≥ 15**

Generator		115/200/230/400V 50Hz					138/240/277/480V 60Hz			
Old model	New model	Poles	S [KVA]	STAB	L[33]	L[53]	S [KVA]	STAB	L[33]	L[53]
ECP3-1S/2	/	2	8	5	12480	4753	9,6	4	8576	2245
ECP3-2S/2	/	2	10	5	12480	4753	12	4½	10559	3403
ECP3-3S/2	/	2	12,5	5	12480	4753	15	4½	10559	3403
ECP3-1L/2	/	2	16	5½	14400	6328	19,2	5	12480	4753
ECP3-2L/2	/	2	19	5½	14400	6328	22,4	5	12480	4753
/	ECP3-2L/2	2	20	-	-	-	24	-	-	-
ECO28-1LN/2	ECP28-M/2	2	22	6½	18368	10296	26,4	-	-	-
ECO28-2LN/2	ECP28-2L/2	2	27	5½	14400	6328	32,4	5½	14400	6328
ECO28-3LN/2	ECP28-3L/2	2	31,5	5	12480	4753	37,8	-	-	-
ECO28-VL/2	ECP28-VL/2	2	40	7½	22208	15051	48	6	16384	8192
ECO31-2SN/2	ECP32-2S/2	2	44	-	-	-	52,8	-	-	-
ECO31-3SN/2	ECP32-3S/2	2	55	-	-	-	66	-	-	-
ECO31-1LN/2	ECP32-1L/2	2	66	-	-	-	79,2	5	12480	4753
ECO31-2LN/2	ECP32-2L/2	2	82	-	-	-	98,4	-	-	-
/	ECP34-1S/2	2	100	-	-	-	120	-	-	-
/	ECP34-2S/2	2	125	-	-	-	150	-	-	-
/	ECP34-1L/2	2	156	-	-	-	187	-	-	-
/	ECP34-2L/2	2	170	-	-	-	208	-	-	-
ECO3-1SN/4	ECP3-1S/4	4	6,5	6	16384	8192	7,8	6	16384	8192
ECO3-2SN/4	ECP3-2S/4	4	8	5½	14400	6328	9,6	4½	10559	3403
ECO3-1LN/4	ECP3-1L/4	4	11	5	12480	4753	13,2	4½	10559	3403
ECO3-2LN/4	ECP3-2L/4	4	13,5	6	16384	8192	16,2	5½	14400	6328
ECO3-3LN/4	ECP3-3L/4	4	15	6½ <sup>(2)</sup>	18368 <sup>(2)</sup>	10296 <sup>(2)</sup>	18	5½	14400	6328
ECO28-1VS/4	ECP28-1VS/4	4	7,8	5	12480	4753	9,3	4	8576	2244
ECO28-2VS/4	ECP28-2VS/4	4	11	4	8576	2244	13,2	4	8576	2244
ECO28-OS/4	ECP28-OS/4	4	13,5	5½	14400	6328	16,2	5	12480	4753
ECO28-SN/4	ECP28-S/4	4	17	6	16384	8192	20,4	5½	14400	6328
ECO28-1LN/4	ECP28-M/4	4	20	5½	14400	6328	24	5	12480	4753
ECO28-2LN/4	ECP28-2L/4	4	25	7	20288	12561	30	5	12480	4753
ECO28-VL/4	ECP28-VL/4	4	30	7 <sup>(3)</sup>	20288 <sup>(3)</sup>	12561 <sup>(3)</sup>	36	6 <sup>(3)</sup>	16384 <sup>(3)</sup>	8192 <sup>(3)</sup>
ECO32-2S/4	ECP32-2S/4	4	35	5½	14400	6328	42	4½	10559	3403
ECO32-3S/4	/	4	40	6	16384	8192	48	6	16384	8192
/	ECP32-3S/4	4	42,5	-	-	-	51	-	-	-
ECO32-1L/4	ECP32-1L/4	4	50	7½	22208	15051	60	4	8576	2244
ECO32-2L/4	/	4	60	8	24191	17860	72	5½	14400	6328
/	ECP32-2L/4	4	63	-	-	-	75,5	-	-	-
ECO32-3L/4	/	4	70	8½	26176	20908	84	5½	14400	6328
/	ECP32-3L/4	4	75	8½	26176	20908	90	5½	14400	6328
/	ECP32-4L/4	4	80	8½	26176	20908	96	5½	14400	6328
ECP34-1S/4	/	4	85	7½	22208	15051	102	7	20288	12561
ECP34-2S/4	/	4	105	6½	18368	10296	126	6½	18368	10296
ECP34-1L/4	/	4	130	8½	26176	20908	156	6½	18368	10296
/	ECP34-1L/4	4	135				162			
ECP34-2L/4	/	4	150	8½	26176	20908	180	8	24191	17860
/	ECP34-3L/4	4	160	-	-	-	192	-	-	-
ECO38-1SN/4	/	4	180	9	28096	24090	216	6½	18368	10296
ECO38-2SN/4	/	4	200	9	28096	24090	240	8	24191	17860
ECO38-3SN/4	/	4	225	8½	26176	20908	270	7½	22208	15051
ECO38-1LN/4	/	4	250	8½	26176	20908	300	8	24191	17860
ECO38-2LN/4	/	4	300	8	24191	17860	360	max	32704	32640
ECO38-3LN/4	/	4	350	max	32704	32640	420	9½	30077	27610

NOTE 1) DSR: P[11] = 4, P[12] = 3, P[13] = 16384, with STAB trimmer enabled  
 NOTE 2) For standard application; for special application: **STAB=4** → L[33]=8576 → L[53]=2244;  
 NOTE 3) For standard application; YY 230V/60Hz and singlephase Δ 230V/50Hz: **STAB=6** → L[33]=16384 → L[53]=8192

**TABLE 11 NPE32/4: ADVISED STAB TRIMMER SETTING ON DSR<sup>(1)</sup> Fw Rel. ≥ 15**

NPE32 1-PHASE <sup>(4)</sup>		230V / 50Hz				240V / 60Hz			
Type	Poles	S [KVA]	STAB	L[33]	L[53]	S [KVA]	STAB	L[33]	L[53]
NPE 32-A/4	4	6,4	6 ½	18368	10296	8,4	-	-	-
NPE 32-B/4	4	8,7	5 ½	14400	6328	10,5	5 ½	14400	6328
NPE 32-C/4	4	10,8	6	16384	8192	13	6	16384	8192
NPE 32-D/4	4	13,8	7	20288	12561	17	5 ½	14400	6328
NPE 32-E/4	4	18,5	-	-	-	22	6	16384	8192
NPE 32-F/4	4	22,5	6	16384	8192	26,5	6	16384	8192

NPE32 3-PHASE		115/200/230/400V 50Hz				138/240/277/480V 60Hz			
Type	Poles	S [KVA]	STAB	L[33]	L[53]	S [KVA]	STAB	L[33]	L[53]
NPE 32-A/4	4	7,5	4 ½	10559	3402	9	5	12480	4753
NPE 32-B/4	4	11,5	5 ½	14400	6328	14	5	12480	4753
NPE 32-C/4	4	13	-	-	-	16	-	-	-
NPE 32-D/4	4	17	5 ½	14400	6328	21	5	12480	4753
NPE 32-E/4	4	25	6	16384	8192	31	5	12480	4753
NPE 32-F/4	4	27,5	5 ½	14400	6328	34	5	12480	4753

**TABLE 12 ECO40-43-46: ADVISED STAB TRIMMER SETTING ON DSR<sup>(5)</sup> Fw Rel. ≥ 15**

Generator			Nominal Frequency = 50Hz				Nominal Frequency = 60Hz			
Old model	New model	Poles	S [KVA]	STAB	L[33]	L[53]	S [KVA]	STAB	L[33]	L[53]
ECO40-1S/4	/	4	400	9	28096	24090	480	7	20288	12561
ECO40-2S/4	/	4	450	8 ½	26176	20910	540	8	24191	17860
ECO40-3S/4	/	4	500	9	28096	24090	600	8 ½	26176	20908
ECO40-1L/4	/	4	550	9	28096	24090	660	8 ½	26176	20908
ECO40-1.5L/4	/	4	620	9	28096	24090	744	-	-	-
ECO40-2L/4	/	4	680	9 ½	30077	27610	816	7	20288	12561
ECO40-VL/4	/	4	720	9	28096	24090	864	7 ½	22208	15051
/	ECO40-VL/4	4	750	-	-	-	900	-	-	-
ECO43-1SN/4	/	4	800	9	28096	24090	960	7 ½	22208	15051
ECO43-2SN/4	/	4	930	9	28096	24090	1116	8	24191	17860
ECO43-1LN/4	/	4	1100	9	28096	24090	1320	8 ½	26176	20908
ECO43-2LN/4	/	4	1300	9 ½	30077	27610	1560	8	24191	17860
/	ECO43-VL/4	4	1400	9 ½	-	-	1700	-	-	-
ECO46-1S/4	/	4	1500	8	24191	17860	1800	6 ½	18368	10296
ECO46-1.5S/4	/	4	1650	9	28096	24090	1980	8 ½	26176	20908
ECO46-2S/4	/	4	1800	8 ½	26176	20908	2160	8	24191	17860
ECO46-1L/4	/	4	2100	max	32704	32640	2520	9	28096	24090
ECO46-1.5L/4	/	4	2300	9	28096	24090	2760	9	28096	24090
ECO46-2L/4	/	4	2500	9 ½	30077	27610	3000	9	28096	24090

- NOTE 1) DSR: P[11] = 4, P[12] = 3, P[13] = 16384, with STAB trimmer enabled  
 NOTE 2) For standard application; for special application: **STAB=4** → L[33]=8576 → L[53]=2244;  
 NOTE 3) For standard application; YY 230V/60Hz and singlephase Δ 230V/50Hz: **STAB=6** → L[33]=16384 → L[53]=8192;  
 NOTE 4) Dedicated winding  
 NOTE 5) **DSR/A**: P[11] = 5, P[12] = 1, P[13] = 26624, with Fcig<sub>60</sub>(L[53]) = Fcig<sub>50</sub>(L[53]) = L[53]

### 3. Excitation Overcurrent

#### 3.1 Description

The DSR regulator is equipped with an excitation winding temperature estimator (mainly rotor). An estimate of the temperature (in relative values) is available in real time (and it can be read) in location 45; in the lower part of the main window of the DxR terminal software there is a graphic representation of location 45. The progress of the temperature is of the exponential type (see figure 8).

Through parameter 22 or the AMP trimmer, it is possible to define a limit (which involves intervention of alarm 5) to the excitation voltage and therefore to the temperature.

The function of this alarm is not only to signal an excessive temperature, but it also has an active function in reducing the cause. In fact, an adjustment ring takes control of the voltage generated when the threshold set is exceeded: This reduces the voltage to the point of reducing the excitation current by a value compatible with the ability of thermal dissipation of the machine. The stability of the regulation in case of overexcitation alarm, if necessary, may be adapted to the application by varying the value of parameter 28 (5)

For an increased protection of the electrical machine, starting from rev. 18 of the firmware, the excitation overcurrent protection was extended to the whole speed interval (frequency) of the alternator, particularly for the lower frequencies, to a preset threshold (56.7Hz with the jumper inserted between the 12 and 13 terminals of connector CN1, if enabled, or, otherwise, if the 50/60, 49Hz setting is enabled) the protection intervenes with an effective threshold (relative to the one set through the AMP trimmer or parameter 22) reduced proportionally to the frequency.

The extent of this reduction depends on parameter 29 which is by default set to an adequate value for the standard alternators, used in three-phase in nominal voltage.

An increment of the value of P[29] determines a bigger reduction of the intervention threshold, based on the frequency reduction, a decrease of the value of P[29] determines a smaller reduction of the intervention threshold.

**Caution !**

If the magnetic gain of the alternator is high, unstable events may occur when the protections intervene, therefore it is necessary to adjust parameter 28 (usually by reducing its value).

When the alternator works with reduced load and speed, overheating, which is dangerous to the integrity of the machine, might occur, if the overcurrent protection threshold is not sufficiently reduced when reducing the frequency.

As you can see in figure 8, when the estimated temperature (represented by the continuous lines) reaches the threshold value, the reduction of the excitation current (and the subsequent drop of generated voltage) determine the stabilization of the temperature around a limit value.

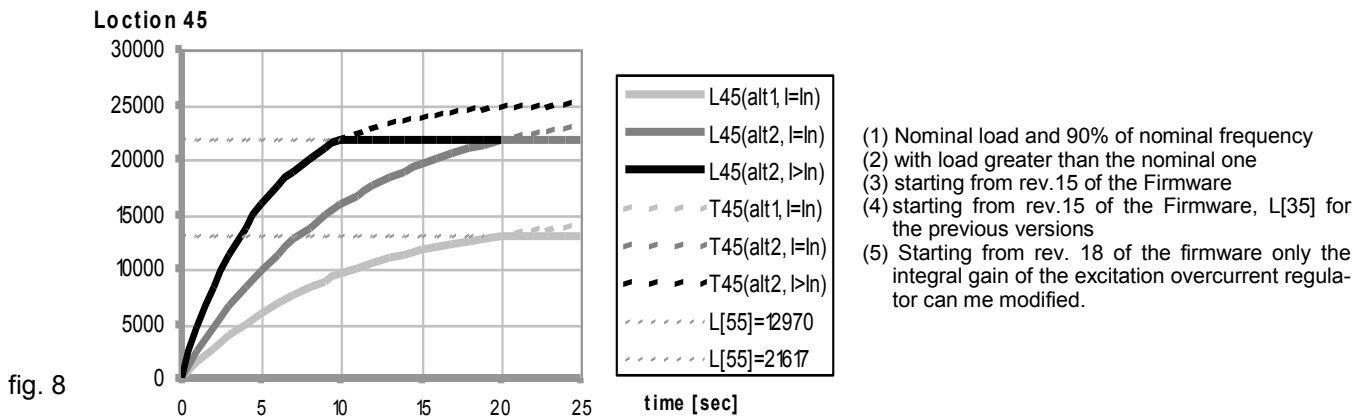

- (1) Nominal load and 90% of nominal frequency
- (2) with load greater than the nominal one
- (3) starting from rev.15 of the Firmware
- (4) starting from rev.15 of the Firmware, L[35] for the previous versions
- (5) Starting from rev. 18 of the firmware only the integral gain of the excitation overcurrent regulator can be modified.

#### Curve Description

L45 (alt1, I=In) : value read at location 45 with a certain alternator (1)

L45 (alt2, I=In) : value read at location 45 with a second alternator of a different type (1)

L45 (alt2, I>In) : value read at location 45 with the second alternator during overloading (2)

T45 (alt1, I=In) : value that would be read at location 45 with the first alternator, without protection (1)

T45 (alt2, I=In) : value that would be read at location 45 with the second alternator, without protection (1)

T45 (alt2, I>In) : value that would be read at location 45 with the second alternator during overloading, without protection (2)

L[55]=12970 Represents the value of the current limit set using the AMP trimmer or the P[22] parameter for the first alternator (3)

L[55]=21617 Represents the value of the current limit set using the AMP trimmer or the P[22] parameter for the second alternator (3)

### 3.2 Calibration with a supervision unit

To calibrate the overload protection, when the machine is cold, perform the following procedure:

- 1) turn the AMP trimmer fully clockwise (if enabled from the **Settings/Potentiometers** menu) or write 32676 in location 22
- 2) apply to the alternator an overload having  $\cos\phi = 0.8$  or  $\cos\phi = 0$  respectively equal to 125% or 110% of the nominal load
- 3) read the value displayed at location 45, 2 minutes after the overload application
- 4) if the AMP trimmer is enabled turn it anti-clockwise until the value read at location 55<sup>(4)</sup> becomes equal to the value read at point 3 (location 45); the operation is simplified a lot by using the DxR terminal software which provides, in the lower part of the main window, a graphic representation of the time evolution of locations 45 ("real excitation", red line) and 55 ("excitation threshold" - yellow line): the intervention threshold must be calibrated so that the yellow line should intersect the red line when, from the application of the load, the time specified at point 3 has passed.
- 5) if the AMP trimmer is not enabled, write the value read at point 3 (location 45) in location 22.
- 6) Alarm 5 should set off (visible both on the main panel of the DxR Terminal and through a change in the LED flash) and the voltage should start to decrease.
- 7) If the load is removed, alarm 5 disappears after a few seconds and the generator voltage goes back to the nominal value.

### 3.3 Calibration without a supervision unit

NB: this calibration can be performed only if the AMP trimmer was previously enabled.

To calibrate the overload protection, perform the following procedure:

- 1) turn the AMP trimmer fully clockwise
- 2) feed the alternator an overload having  $\cos\phi = 0.8$  or  $\cos\phi = 0$  respectively equal to 125% or 110% of the nominal load
- 3) after two minutes slowly turn the AMP trimmer anti-clockwise until you get a reduction of the generator's voltage value and the activation of alarm 5 (visible through a change in the LED flash)
- 4) Calibrate the AMP trimmer so as to get an output voltage value of 97% of the nominal value: alarm 5 is still active.
- 5) If the load is removed, alarm 5 disappears after a few seconds and the generator voltage goes back to the nominal value.



NOTES: If the machine is used in single phase or voltages different to the ones set by the producer, a recalibration of the overexcitation protection might be necessary.  
If it is not possible to apply the prescribed overload, the overexcitation condition may be simulated by adequately increasing the regulated voltage so as to get an excitation current equivalent to the overload current.

## 4. Underspeed

### 4.1 Description

For speeds lower than a configurable threshold the machine voltage is no longer constant, but regulated proportionally to the frequency with a rate which is also configurable as it can be seen in figure 9a and 9b. The intervention threshold depends:

- on the status of the 50/60 jumper (connector CN1 terminals 12 and 13), if enabled (ref. **Settings/UFLO&LAMS** menu)
- on the 50/60 setting status (ref. **Settings/UFLO&LAMS** menu)
- on the position of the Hz trimmer if enabled (ref. **Settings/Potentiometers** menu)
- on the value of parameter 21. (ref. **Settings/UFLO&LAMS** menu or Transmit/Receive area of the Settings/Advanced menu)

Activation of the function with voltage proportionate to the frequency is signalled by activation of alarm 6 (visible from the DxR Terminal control panel and due to a change in the flashing indicator light).

**Parameter 21** (equivalent to the Hz trimmer) sets the Underspeed protection intervention threshold; if this is set on 16384, the protection cuts in at 45 Hz (if the 50/60 jumper and 50/60 flag in the **Settings/UFLO&LAMS** Menu are not present) or at 54 Hz (if the 50/60 jumper is enabled or the 50/60 flag is active in the **Settings/UFLO&LAMS** Menu). Values between 0 and 16384 proportionately lower the threshold, respectively to 40 Hz and 48 Hz; values between 16384 and 32767 proportionately raise the threshold, respectively to 50 Hz and 60 Hz.

Once the underspeed protection has intervened, the frequency is proportionately reduced, as indicated in

figure 9a and 9b. **Parameter 23** sets the slope of the voltage/frequency curve; the default value is 9000. An increase in the value of P23 involves a greater reduction of the voltage as a function of the reduction in frequency. A reduction of the value of P23 determines a smaller reduction of the voltage up to the limit case of P[23]=0 which entails not getting any voltage reduction. The above-mentioned calibrations are simplified a lot by using the DxR terminal software which allows, in the **Settings/UFLO&LAMS** menu, through a graphic interface, to change parameters 21 and 23 (with a concurrent disabling of the Hz trimmer) providing the preview of the V/f ratio in the setting phase.



**WARNING:** Overheating could occur, which is dangerous for the machine, if the voltage is not lowered enough to decrease the frequency and the alternator is functioning at a reduced speed.

**4.2 Calibration with a supervision unit**

Use the following procedure in order to calibrate the underspeed protection:

- 1) if the machine must operate at 60 Hz, make sure you insert the jumper between terminals 12 and 13 of the CN1 connector, if enabled, or enable the 50/60 setting (ref. **Settings/UFLO&LAMS** menu).
- 2) if the Hz trimmer is enabled, the protection intervention threshold value is read at location 34, otherwise it is written directly at parameter 21.

The 16384 value written at parameter 21 (or read at location 34) corresponds to a 45/54 Hz intervention (based on whether 50/60 is enabled or not).

Values ranging from 0 to 16384 correspond to an intervention varying from 40/80Hz to 45/54Hz.

Values ranging from 16384 to 32767 correspond to an intervention varying from 45/54Hz to 50/60Hz.

The operation is much facilitated by the use of the DxR terminal software which provides a graphic representation of the time evolution of the measured frequency (red line) and of the intervention threshold (green line)

- 3) when the speed decreases under the threshold value the voltage of the generator starts to diminish and alarm 6 is simultaneously visualized on the LED and on the main window of the DxR Terminal software
- 4) increasing the speed, the voltage of the generator should go back to normal and alarm 6 should disappear.

**4.3 Calibration without a supervision unit**

NOTE: this calibration can be performed only if the Hz trimmer and 50/60 jumper have been previously enabled.

Use the following procedure in order to calibrate the under speed protection:

- 1) Rotate the Hz trimmer entirely in the counter clockwise direction.
- 2) If the machine has to operate at 60 Hz, ensure that the bridge is inserted between terminals 12 and 13 of the CN1 connector.
- 3) Bring the generator to 90% of the nominal speed.
- 4) Slowly turn the "Hz" trimmer, rotating it clockwise until the generator voltage begins to drop and ascertain that the indicator light simultaneously begins flashing rapidly.
- 5) By increasing speed, the generator voltage will normalise and the alarm will disappear.
- 6) Set the speed to the nominal value.

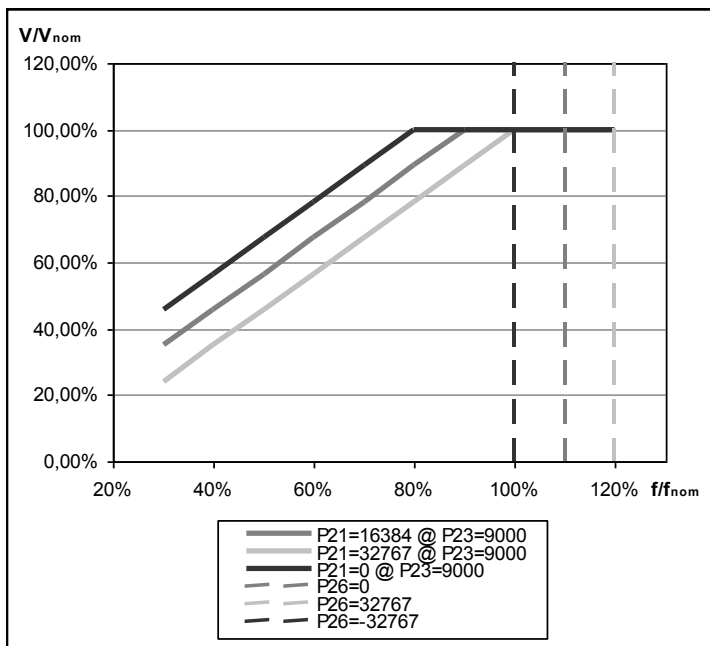

fig. 9a: Underspeed and Overspeed protection, P[21] e P[26]

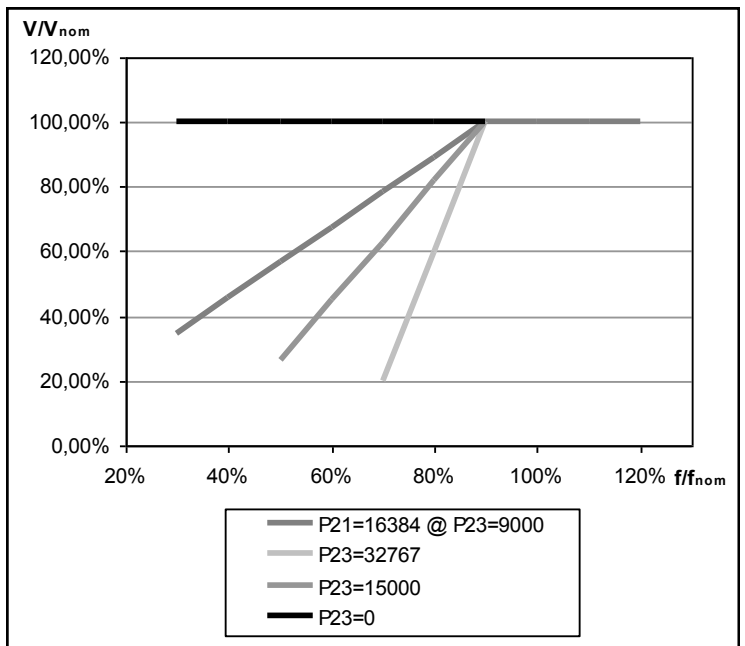

fig. 9b: Voltage slope in underspeed protection, P[23]

## 5. Overspeed

Parameter 26 sets the intervention threshold of the overspeed alarm; if it is set to 0, the warning occurs at 55Hz (if the 50/60 jumper and the 50/60 setting in the **Settings/UFLO&LAMS** menu are absent) or at 66Hz (if the 50/60 jumper is present and enabled or if the 50/60 setting is enabled in the **Settings/UFLO&LAMS** menu). Values between 65535 (-1) and 32768 (-32767) lower the threshold proportionately to 50 Hz and 60 Hz, respectively; values between 0 and 32767 raise the threshold proportionately, respectively to 60 Hz and 72 Hz; refer to the broken lines in fig. 9a and 9b.

## 6. Other parameters

### 6.1 Vout / Vaux Ratio

In order to guarantee sufficient feeding voltage at speeds lower than the Hz protection intervention threshold, a limit to the reduction of voltage has been foreseen, as a function of frequency.

The limit concerns regulated voltage (Vout). Should the DSR be powered through an auxiliary winding, it must be born in mind that the voltage generated by the winding (Vaux) may not have the same Vout value; Vaux is considered proportionate to Vout and the proportional coefficient is determined by **parameter 14**.

If the DSR is powered directly by the regulated phase, parameter 14 should be set on 0; in case it is powered by auxiliary winding, the voltage (Vaux) must be measured, in no-load conditions and with output voltage regulated on the nominal value (Vout); the value of parameter 14 can be obtained with the following formula:

$$P[14] = 32767 \cdot \left( \frac{V_{out}}{V_{aux}} - 1 \right)$$

### 6.2 V/F slope at start up

**Parameter 24** sets the gradient of proper voltage / frequency at start up. After the underspeed alarm frequency threshold has been exceeded (set by parameter P[21] or by the Hz trimmer), the work ramp is used (parameter P[23]).

The default value is 12000; an increase in the value of P24 will cause a greater reduction of low frequency voltage; a decrease in the value of P24 will cause a lower reduction in voltage, up to the limit of P[24]=0, which means that no reduction in voltage will take place.



**WARNING:** If the voltage is not lowered enough with low frequency and the alternator is operating in these points, overheating could develop that is dangerous for the machine.

### 6.3 Short circuit time

**Parameter 25** defines the operating time with the alternator short circuited, which is expressed in tenths of a second (from 0.1 seconds to 25.5 seconds); after this period of time the regulator goes to the blocked status; a value of 0 disables the blockage.

### 6.4 Intervention threshold of low excitation alarm

Starting from rev. 18 of the firmware a warning (alarm A-08) was added in case of low excitation or loss of excitation: if the measured value of excitation voltage does not fall within a preset value range, the anomalous operating condition is signaled (visible on the main panel of the DxR Terminal through the A-08 alarm indicator); no other action is performed by the regulator, except for the switching of APO (if set).

The numeric value identifying in real time the excitation condition is available at location L[56]; the upper detection threshold cannot be modified while the lower threshold can be configured through parameter P[27].

The alarm is activated when the value assumed by location L[56] is higher than the upper threshold or lower than the value assumed by parameter P[27]

For the generators in stand-alone operations, the loss of excitation, on a working regulator, implies also the activation of the low voltage alarm. The underexcitation / loss of excitation alarm is mainly intended for the applications in grid-parallel mode, provided that the regulator stay fully operational (for instance with sufficient residual voltage, direct supply from the phase or from PMG).



**CAUTION!** :In case of parallel operation of the generators and, most of all, in case of grid-parallel mode, given that the activation of the underexcitation/loss of excitation alarm does not imply any other action, except for the signalling and switching of APO (if enabled), the protection of the system is transferred to at least an appropriate management of the above-mentioned signalling. However, no guarantee is offered for the capacity of the exclusive use of this protection to safeguard the system from all the possible functional anomalies correlated to underexcitation / loss of excitation.



# CONTROLLING OF REGULATOR ALARMS

## 1. Table of recapitulation

TABLE 13 : ALLARMS LIST		
N.	Description of event	Action
1	Checksum EEPROM	Reset default data - Blockage
2	Over voltage (@ $\omega_N$ )	APO
3	Under voltage (@ $\omega_N$ )	APO
4	Short circuit	APO, maximum current - Blockage
5	Excitation Overcurrent	APO, Reduction of excitation current
6	Underspeed	APO, V/F Ramp
7	Overspeed	APO
8	Underexcitation /loss of excitation	APO

The status of active alarms is stored at location 38, which can be read with the USB connection.

The index of bits that have a value of 1 corresponds to the active alarm. If the regulator is correctly working (no alarm active) the bit 11 will be high.

TABLE 14 : ALLARMS FLAG AT LOCATION 38															
Location 38 (third "STATUS" box)															
B <sub>15</sub>	B <sub>14</sub>	B <sub>13</sub>	B <sub>12</sub>	B <sub>11</sub>	B <sub>10</sub>	B <sub>9</sub>	B <sub>8</sub>	B <sub>7</sub>	B <sub>6</sub>	B <sub>5</sub>	B <sub>4</sub>	B <sub>3</sub>	B <sub>2</sub>	B <sub>1</sub>	B <sub>0</sub>
32768	16384	8192	4096	2048	1024	512	256	128	64	32	16	8	4	2	1
				A12	A11	A10	A9	A8	A7	A6	A5	A4	A3	A2	A1
J50/60	-	Reserved	Reserved	OK	-	-	-	Underexcitation	Overspeed	Underspeed	OverExcitation	Cto.Cto.	Undervoltage	Overvoltage	Check sum

Example:

Location 38 = 48 = 000000000110000<sub>2</sub> : it means that Bits B5 and B4 are at 1, therefore alarms A6 and A5 are active

## 2. Alarm signals with the indicator lights

During normal operation (OK diagram in fig. 10) a LED indicator mounted on the card flashes with a period of 2 sec and duty cycle of 50%; in case of intervention or signalling of some of the alarms, there are different flash modalities as specified in fig. 10.

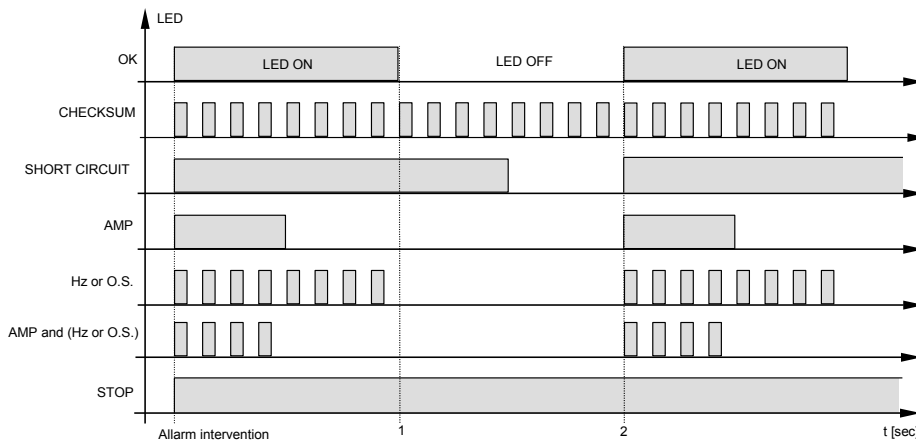
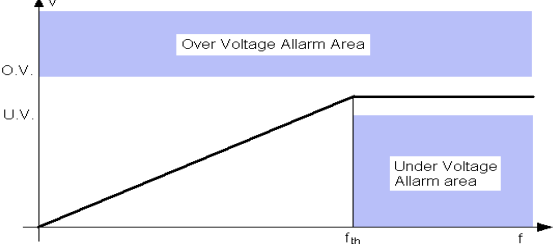

fig. 10

## 2. Description of alarms

N.	Description of event	Action
1	EEPROM checksum	Verified upon start up (after DSP reset and initialisation of the peripheral). The actions undertaken are: signalling, locating of default settings, saving in EEPROM and regulator blockage. When the machine is switched on again, if the EEPROM is damaged, the alarm will be repeated. Otherwise the regulator will begin to function with default parameters.
2	Over Voltage	<p>The alarm does not determine a change in the LED flash, the APO output is active and the alarm is memorised. This can be caused by abnormal operating conditions (such as overspeed or overloading) or by a breakdown of the regulator. The over voltage alarm is activated if the output voltage is lost. The over voltage is calculated using an opportune template, as a function of the speed and is inhibited during transition, for 2 seconds. In the template for the calculation the threshold is set at 5% above the nominal value.</p> 
3	Under voltage (@ $\omega_N$ )	The alarm does not determine a change in the LED flash, is stored and the APO output is active. The under voltage is calculated using an opportune template as a function of the speed (which can be seen in the description of the over voltage alarm); in the template for the calculation the threshold is set at under 5% the nominal value. It intervenes only above the underspeed alarm threshold; it is practically inhibited by this. It is also inhibited in the event of intervention of the Excitation over voltage and during transients.
4	Short circuit	The alarm is disabled under 20 Hz, is visualised upon activation of the action and memorised. Tolerated short circuit time goes from 0,1 to 25,5 seconds (programmable in 100 ms steps); then the regulator is blocked after saving DD and TT and signals the STOP status. With the time in short circuit set on zero, the blockage is disabled. The STOP condition causes a fall in excitation, with consequent switching off and successive restarting of the regulator and therefore repetition of the cycle.
5	Excitation Overcurrent	The function of this alarm is not only to signal an excessive temperature, but it also has an active function in reducing the cause. In fact, an adjustment ring takes control of the voltage generated when the threshold set is exceeded the action involves reduction of the excitation current and therefore output voltage. The available parameter is the "threshold", which determines the value of equilibrium at which the system is stabilised. The alarm is signalled and stored. For calibration see the paragraph on excitation overcurrent.
6	Underspeed	Signalling (immediate) and activation of the V/F ramp. This alarm also appears when the machine is started and stopped. The alarm is not saved among EEPROM data. The alarm intervention threshold depends upon the status of the 50/60 jumper (hardware or software) and on the position of the Hz trimmer or the value of parameter 21. Under the threshold the V/ F ramp is active.
7	Overspeed	This is visualised in the same manner as the underspeed alarm and does not involve actions on control, but the alarm is stored. The overspeed condition may provoke an over voltage as in the case of capacitive load. The threshold can be set with parameter 26.
8	underexcitation /loss of excitation	The alarm does not determine a change in the LED flash, enables APO output and is memorized. The alarm condition is recognized by a underexcitation / loss of excitation observer, available for reading at location L[56]: if the value of L[56] is higher than the upper (fixed) threshold or lower than the value of the lower threshold (parameter P[27]), A-08 is activated. The alarm is inhibited during transients.



**NOTE:** Though the voltage is continuously regulated, the DSR will switch off if the frequency goes under 20Hz. To reset the system it is necessary to stop completely the alternator.

#### 4. APO Output

The APO output status ((Transistor open collector Active Protection Output - connector CN1 terminals 14 and 15)

depends on:

- whether some alarms are activated or not
- setting of parameter P[17]
- setting of the "APO Invert" flag <sup>(2)</sup>

In normal operating conditions it is closed <sup>(2)(3)</sup>. It opens <sup>(2)</sup> (with a configurable delay from 0 to 15 seconds) when, of all the alarms, one or several separately selectable alarms are active and the "APO Invert" flag <sup>(2)</sup> is active or, immediately, in case of absence of power supply to the regulator; if the "APO Invert" flag <sup>(2)</sup> is inactive (or for firmware revisions lower than 18) the APO output is inverted (open in normal operating conditions or with regulator switched off, closed, with a configurable delay, in case of one or several active selected alarms).

The selection of which alarms trigger the activation of A.P.O. depends on the value written at location 17. The transistor is closed <sup>(2)(3)</sup> both when no alarm is active and when, even if the alarm is active, the corresponding enabling bit is set to 0.

The value to set at location 17 is made up of 2 parts: one part allows selection of the alarms which activate the contact, the other one allows setting the intervention delay. To calculate the value to set at location 17 use the following procedure:

- a) In relation to table 15. Add up the decimal numbers corresponding to the alarms for which you want APO to be activated obtaining number B. (Example: if you want APO to be activated for overvoltage and overspeed, you get B = 2 +64 = 66)
- b) Multiply the delay you want (integer values from 0 to 15 seconds) by the fixed value 4096. You get number A = (0..15) \* 4096. (Example: if you want a 5 seconds delay, you get A = 5 \* 4096 = 20480)

The sum A + B must be written at location 17 (In the preceding example 20480 + 66 = 20546)

The configuration is simplified a lot by the use of the DxR terminal software which has the APO settings menu dedicated to this purpose.

**TABLE 15 : ALLARMS SETTING THAT ACT ON THE APO**

A12	A11	A10	A9	A8	A7	A6	A5	A4	A3	A2
-	-	-	-	Underexcitation	Overspeed	Underspeed	Over Excitation	Cto.Cto.	Under voltage	Over voltage
2048	1024	512	256	128	64	32	16	8	4	2

#### 5. DSR operation time <sup>(1)</sup>

If the regulator is working correctly (no alarm) A12 will be active and the bit 11 will be High at location 38.

When we see one alarm, the A12 is deactivated, bit 11 is reset at location 38 and operation time is stored.

The total operation time of the regulator is obtained, after the download of the alarms, by adding all the times TT (last column of the file .alr).

For this procedure please refer to the "DownLoad Alarm" function of the Upload/Download Menu of DxR Terminal Software, see Technical guide "Interface communication USB2DxR".

NOTE (1): starting from rev.11 of the Firmware

NOTE (2): Starting from rev. 18 of the firmware

NOTE (3): Open for firmware revisions lower than 18

## APPENDIX : DSR SET UP ON A TEST BENCH

The operations of functional checkout and parameter setting may turn out to be easier if they are performed on a test bench rather than with the regulator connected to the alternator.

The connection diagrams of the DSR and the USB2DxR communication interface are shown in figures 11a, 11b or 11c based on the requested function and on the available supply voltage.



Given that some parts of the DSR which work at high voltage are not isolated, for the safety of the operator, it is necessary for the power source to be isolated from the electrical grid, for instance by a transformer.

The use of these types of connection is reserved to qualified personnel, able to assess the operational risks of high voltage and who have a full knowledge of the content of this manual.

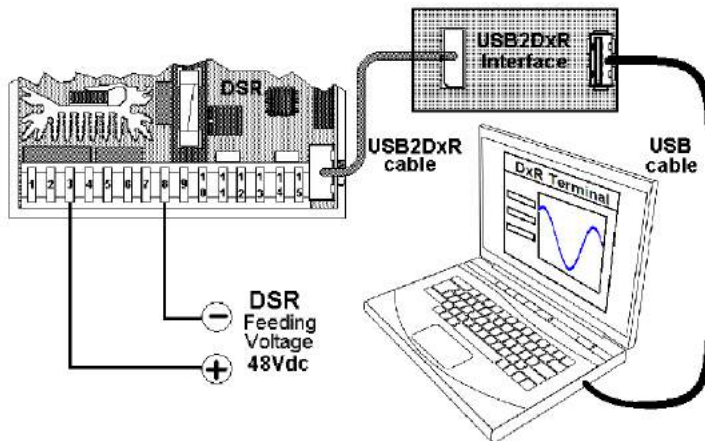

Fig. 11a: DSR 48Vdc power supply (please note that no other connections, other than the power source, are necessary) for the download of the alarms without risking to modify the content of the EEPROM because of the test.

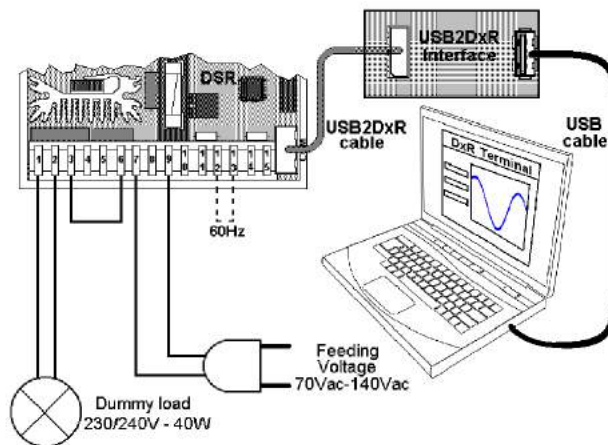

Fig. 11b: DSR 70-140Vac power supply ( Please note the sensing on terminal 7 and the jumper between terminals 6 and 3 of the DSR) for test and setup

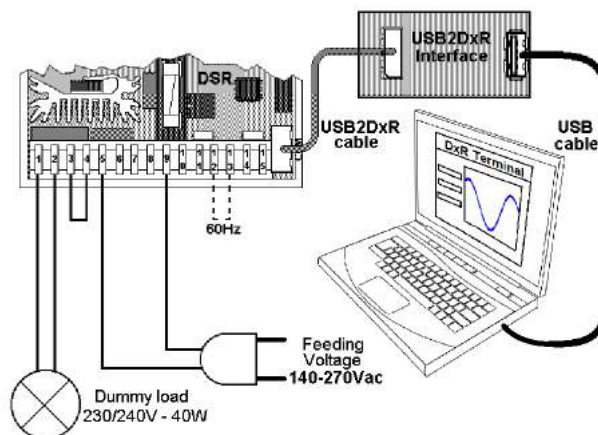

Fig. 11c: DSR 140-270Vac power supply ( Please note the sensing on terminal 5 and the jumper between terminals 4 and 3 of the DSR) for test and setup

## TECHNICAL REFERENCE GUIDES

Title	Link
Communication interface USB2DxR	<a href="http://www.meccalte.com/send_file.php?fileid=Usb2DxR.pdf">http://www.meccalte.com/send_file.php?fileid=Usb2DxR.pdf</a>
Digital Regulators MODBUS communication protocol	<a href="http://www.meccalte.com/send_file.php?fileid=MODBUS">http://www.meccalte.com/send_file.php?fileid=MODBUS</a>
Parallel operation	<a href="http://www.meccalte.com/send_file.php?fileid=parallel%20manual_PD500.pdf">http://www.meccalte.com/send_file.php?fileid=parallel%20manual_PD500.pdf</a>

## REVISION HISTORY

Revision	Date	Description
rev.00	06/07	Initial Release
rev.01	05/08	Firmware update Rev. 7
rev.02	10/08	Firmware update Rev. 9, added Appendix A and Appendix B
rev.03	06/10	Firmware update Rev. 11, DSR/A
rev.04	10/12	Firmware update Rev. 15, added tables of STAB setting
rev.05	03/13	Added explanation of the file .alr and EMI filter SDR128/K connection diagram
rev.06	05/15	Firmware update Rev. 18, elimination of :DI1, DSR Terminal software and DSR Reader, DSR Set up on a test bench update
rev.07	07/15	Corrections at page 12
rev.08	09/16	Update of: all SCC with PD500 , PD-I and AVR wires markers, and fig.5,11a,11b,11c





## MECC ALTE SPA (HQ)

Via Roma  
20 – 36051 Creazzo  
Vicenza – ITALY

T: +39 0444 396111  
F: +39 0444 396166  
E: info@meccalte.it  
aftersales@meccalte.it

## MECC ALTE PORTABLE

Via A. Volta  
137038 Soave  
Verona – ITALY

T: +39 0456 173411  
F: +39 0456 101880  
E: info@meccalte.it  
aftersales@meccalte.it

## MECC ALTE POWER PRODUCTS

Via Melaro  
2 – 36075 Montecchio  
Maggiore (VI) – ITALY

T: +39 0444 1831295  
F: +39 0444 1831306  
E: info@meccalte.it  
aftersales@meccalte.it

## ZANARDI ALTERNATORI

Via Dei Laghi  
48/B – 36077 Altavilla  
Vicenza – ITALY

T: +39 0444 370799  
F: +39 0444 370330  
E: info@zanardialternatori.it

## UNITED KINGDOM

Mecc Alte U.K. LTD  
6 Lands' End Way  
Oakham  
Rutland LE15 6RF

T: +44 (0) 1572 771160  
F: +44 (0) 1572 771161  
E: info@meccalte.co.uk  
aftersales@meccalte.co.uk

## SPAIN

Mecc Alte España S.A.  
C/ Rio Taibilla, 2  
Polig. Ind. Los Valeros  
03178 Benijofar (Alicante)

T: +34 (0) 96 6702152  
F: +34 (0) 96 6700103  
E: info@meccalte.es  
aftersales@meccalte.es

## CHINA

Mecc Alte Alternator Haimen LTD  
755 Nanhai East Rd  
Jiangsu HEDZ 226100 PRC

T: +86 (0) 513 82325758  
F: +86 (0) 513 82325768  
E: info@meccalte.cn  
aftersales@meccalte.cn

## INDIA

Mecc Alte India PVT LTD  
Plot NO: 1, Sanaswadi  
Talegaon  
Dhamdhare Road Taluka:  
Shirur, District:  
Pune - 412208  
Maharashtra, India

T: +91 2137 673200  
F: +91 2137 673299  
E: info@meccalte.in  
aftersales@meccalte.in

## U.S.A. AND CANADA

Mecc Alte Inc.  
1229 Adams Drive  
McHenry, IL, 60051

T: +1 815 344 0530  
F: +1 815 344 0535  
E: info@meccalte.us  
aftersales@meccalte.us

## GERMANY

Mecc Alte Generatoren GmbH  
Ensener Weg 21  
D-51149 Köln

T: +49 (0) 2203 60541-0  
F: +49 (0) 2203 60541-49  
E: info@meccalte.de  
aftersales@meccalte.de

## AUSTRALIA

Mecc Alte Alternators PTY LTD  
10 Duncan Road, PO Box 1046  
Dry Creek, 5094, South  
Australia

T: +61 (0) 8 8349 8422  
F: +61 (0) 8 8349 8455  
E: info@meccalte.com.au  
aftersales@meccalte.com.au

## FRANCE

Mecc Alte International S.A.  
Z.E. la Gagnerie  
16330 St. Amant de Boixe

T: +33 (0) 545 397562  
F: +33 (0) 545 398820  
E: info@meccalte.fr  
aftersales@meccalte.fr

## FAR EAST

Mecc Alte (F.E.) PTE LTD  
10V Enterprise Road, Enterprise 10  
Singapore 627679

T: +65 62 657122  
F: +65 62 653991  
E: info@meccalte.com.sg  
aftersales@meccalte.com.sg



[www.meccalte.com](http://www.meccalte.com)

The world's largest independent  
producer of alternators 1 – 5,000kVA



MASPA: 09.2016 | V08